

EN

2025
2026

BARAZZA
taste of design

The simplicity of stainless steel.
Our ability to
shape it in designer objects.
A penchant
for things designed well,
and made even better.
Our preference for
handcrafted tradition
and technological innovation.
This is what pushes us
to create kitchen solutions
with high performance.
Transforming our passion
into excellence
that creates passion.

BARAZZA: A COMPLETE RANGE OF SOLUTIONS FOR EVERY NEED AND EVERY TASTE.

Collections offer a wide range of coordinated elements. The **Fusion** line offers made-to-measure and built-in worktops for a custom kitchen. With **Made to measure**, the customer has total freedom to create their own custom design. The **Outdoor** collection was created to furnish outdoor spaces.

Functionality and style in every environment.



1 / COLLECTIONS



2 / FUSION



3 / MADE TO MEASURE



4 / OUTDOOR

1 / COLLECTIONS

Barazza Collections offer elegant oven systems and coordinated products, hobs, cooker hoods, refrigerators, dishwashers, sinks, accessorised channels, taps and accessories.



Each piece is created with a distinctive aesthetic, as coordinated details, various types of edge, exclusive steel finishes, knobs and dedicated accessories add prestige and personality, making each kitchen unique and personal.





AURA



ICON





VELVET ADVANCE



MIZU KASAI



LAB EVOLUTION



LAB



MOOD



UNIQUE



B_FREE



SELECT PLUS



ZERO ADVANCE

A close-up, high-angle shot of a dark, minimalist kitchen island. The island features a stainless steel double-basin sink with a modern, curved faucet. To the right of the sink is a dark, flat cooktop with a rectangular vent. On the left side of the island, a stack of three dark plates is placed. The background shows a window with a view of trees and water.



OFFICINA

A full view of a dark kitchen. On the left, a built-in oven and microwave are stacked vertically. In the center, a stainless steel gas cooktop is integrated into the dark countertop. To the right, a stainless steel double-basin sink with a modern faucet is visible. The countertop is dark and minimalist. A window in the background provides a view of a forested landscape.



75 CM MODULARITY



CITY



ACCESSORISED CHANNELS



TAPS AND ACCESSORIES

2 / FUSION

Fusion is a made-to-measure built-in steel worktop providing every function in a space that's pure design. Fusion combines cooking and washing elements in custom sizes to create original solutions for exclusive kitchens. Functionality, practicality and ease of cleaning.



LAB FUSION



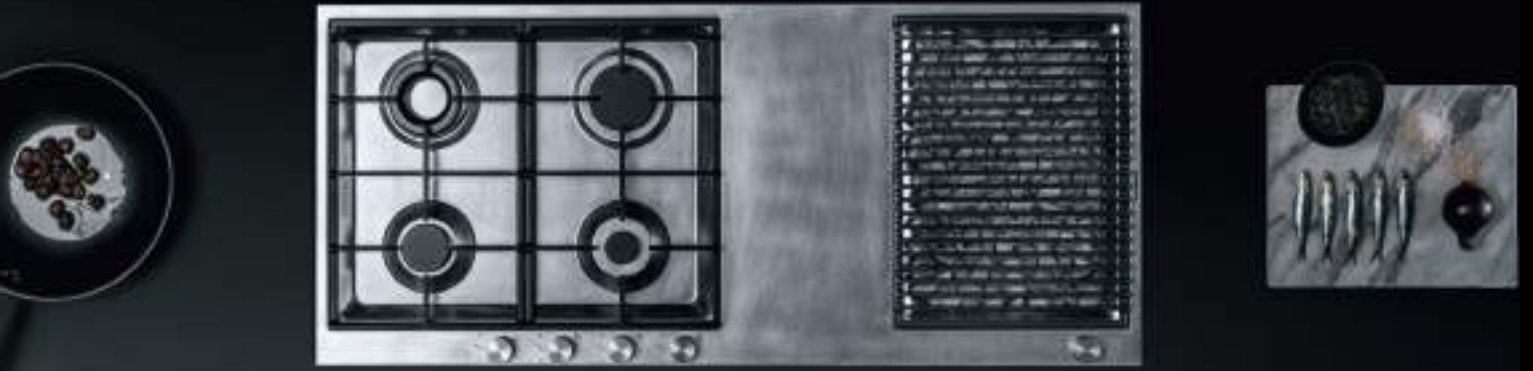

B_FREE FUSION



MOOD FUSION

3 / MADE TO MEASURE

Made to Measure most fully expresses all Barazza has to offer. Backed by its know-how, Barazza transforms materials into infinite forms. The cooking and washing elements in custom sizes and finishes create solutions tailored to what customers need and want. Italian know-how, an eye for beauty and attention to functionality bring to life solutions that meet personal, functional, aesthetic and value-related demands.





MADE TO MEASURE. INSIDE DESIRES.

The evolution of the
species continues.

Barazza offers unique solutions to create custom kitchen environments, offering the widest selection of options and full freedom to choose. The made-to-measure versions are born from Barazza's most innovative creations and from being able to develop and modify them in order to fulfil particular requirements of taste, size and style. The result is our "tailor-made" solutions, made to measure to meet the needs and wishes of our clients.



Combining cooking and washing equipment in customised sizes and finishes, you can obtain original, highly exclusive results. An especially wide range of options, that are easy to peruse online at www.barazzasrl.it.

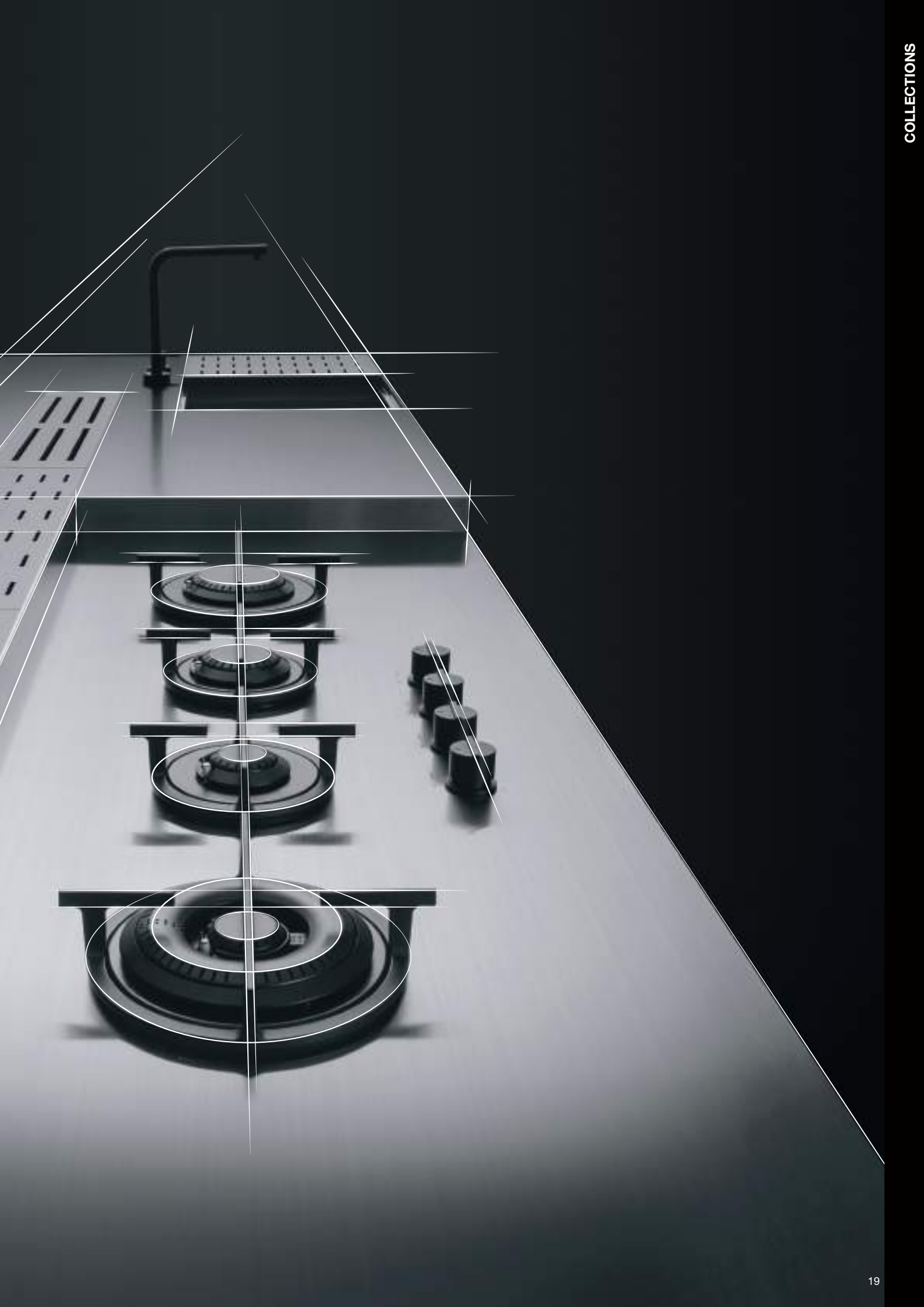

4 / OUTDOOR

A desire for freedom pervades the spirit of Barazza's Outdoor collection. The beauty of the design becomes a tool to give life to functionalities never experienced before. This gives rise to a collection designed to intensify that feeling of freedom that fills each of us and that becomes concrete in infinite possibilities for managing our time in new spaces. Previously unknown horizons of sun, sea and greenery frame our most exciting moments, to be experienced without any cares thanks to the robustness of AISI 316 stainless steel, a material that's particularly beautiful to look at and extremely resistant to atmospheric agents.





Outdoor



archiproducts
AWARDS
WINNER



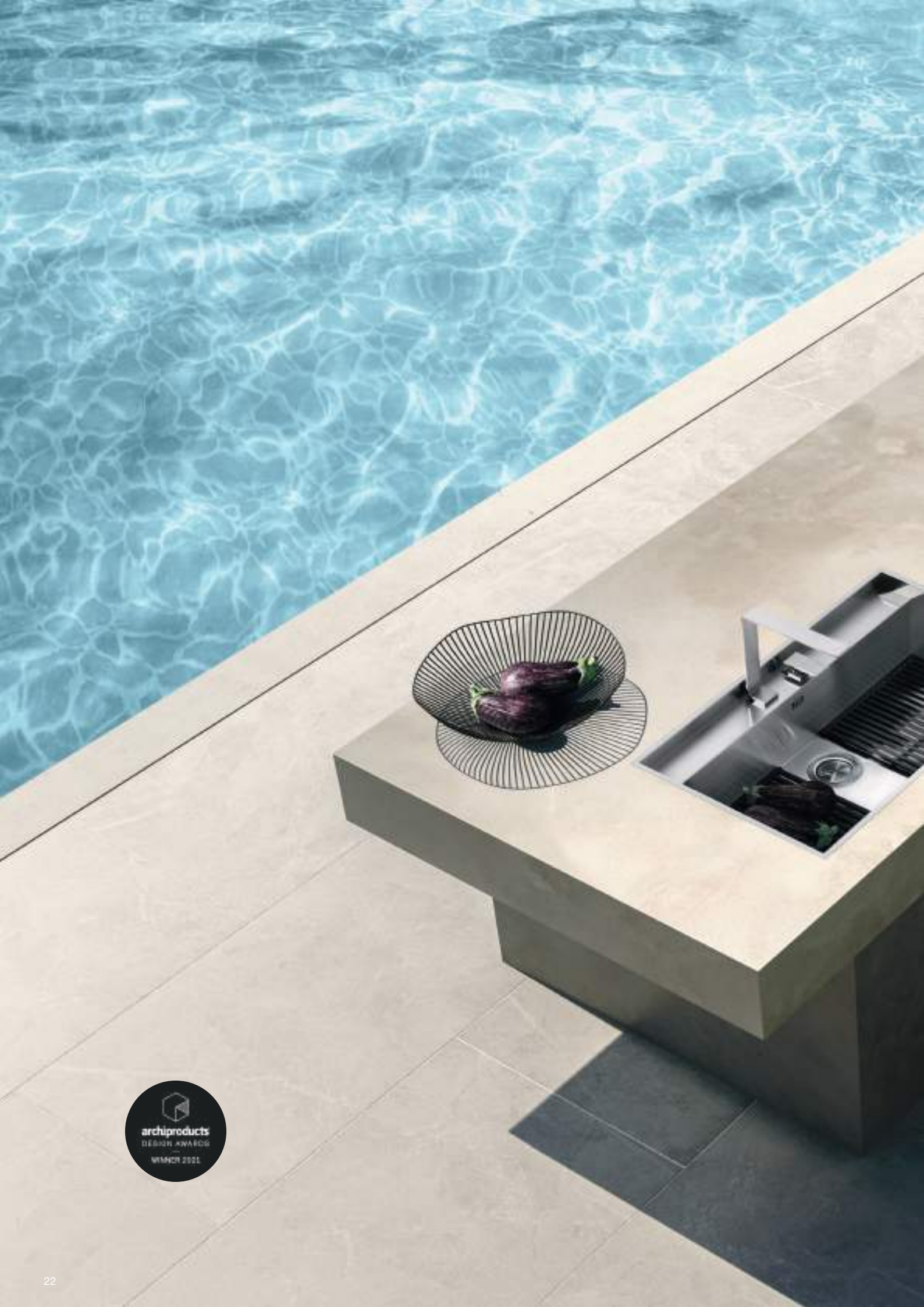



GENERAL CONTENTS



Barazza offers a full range of coordinated refrigerators, dishwashers, ovens, coffee makers, warming drawers and vacuum sealer drawers, hobs, cooker hoods, sinks, accessorised channels, taps and accessories, to satisfy demanding customers who want to express their creativity in the kitchen.

COLLECTIONS



OVENS AND COORDINATED PRODUCTS

page 26



HOBS

page 44



COOKER HOODS

page 66



REFRIGERATORS AND DISHWASHERS

page 74



STAINLESS STEEL
SINKS AND SQUARE BOWLS

page 80



B_GRANITE SINKS AND
SQUARE BOWLS

page 110



ACCESSORISED CHANNELS

page 116



OUTDOOR

page 134



TAPS AND ACCESSORIES

page 142



TECHNICAL INFORMATION

page 176



ICON



ICON ONE



ICON X



ICON XL

ICON OVEN

60 cm built-in

60 cm Icon built-in oven
Touch control + knobs



Exclusive



Steel



Glass

Zefiro



energy rating **A**

Accessories: **28** **79** **80**

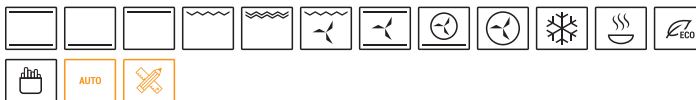

- Zefiro sanitisation system
- 13 manual functions
- 16 automatic cooking programs + Cleaning
- 30 customisable cooking programs
- Veggy mode
- maximum temperature: 250 °C
- capacity: 66 litres
- Touch control multilingual digital programmer + knobs
- features: front controls, knobs and handle in Soft-Touch finish, Easy Clean oven interior, extractable and removable door with triple heat-reflecting glass, Soft-Close hinges, tangential cooling fan, drop-down grill, 2 rear lights, side racks
- equipment: 1 deep Easy Clean enamelled steel drip tray, 1 Easy Clean enamelled steel drip tray, 2 pairs of telescopic oven rails
- safety devices: safety switch-off, electronic child-safety lock
- maximum absorbed power: 2.7 kW

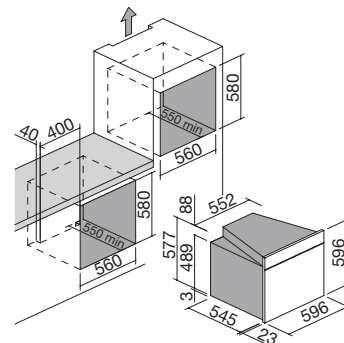

MATT BLACK STAINLESS STEEL

code **1FEVEPN**

SATIN STAINLESS STEEL

code **1FEVSP**

BLACK GLASS

code **1FEVGP**

Accessories:

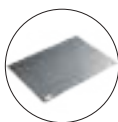

28

code **1PPI**

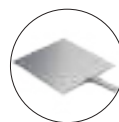

79

code **1PPZ**



80

code **1CFFA**



ICON COMBI-MICROWAVE OVEN

60 cm built-in h. 45

Icon built-in compact combi-microwave oven

Touch control + knobs



Exclusive



Steel



Glass



Accessories: 28 79 80

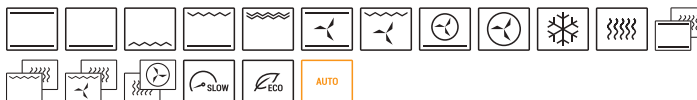

- 17 manual functions
- 20 automatic cooking programs
- 5 automatic defrosting programs
- Veggy mode
- microwave functions up to 1000 W
- maximum temperature: 250 °C
- capacity: 40 litres
- Touch control multilingual digital programmer + knobs
- features: front controls, knobs and handle in Soft-Touch finish, Easy Clean oven interior, extractable and removable door with triple heat-reflecting glass, Soft-Close hinges, tangential cooling fan, internal light, side racks
- equipment: 1 Pyrex baking tray, 1 steel rack
- safety devices: electronic child-safety lock
- maximum absorbed power: 3.5 kW

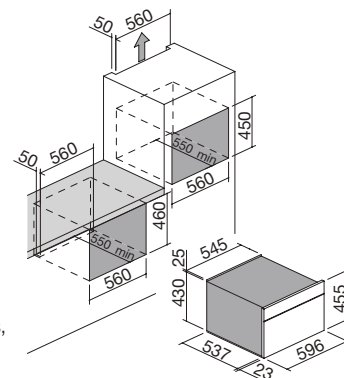

MATT BLACK STAINLESS STEEL

code **1FEVEMCN**

SATIN STAINLESS STEEL

code **1FEVSMC**

BLACK GLASS

code **1FEVGMG**

Accessories:

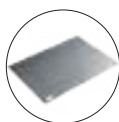

28

code **1PPI**

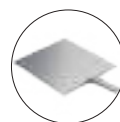

79

code **1PPZ**



80

code **1CFFA**



ICON COFFEE MACHINE

60 cm built-in h. 45

Icon built-in compact coffee machine

Digital programmer + knobs



Exclusive



Steel



Glass



- 5 levels of coffee strength (extra-light, light, normal, strong, extra-strong)
- 3 coffee levels (short, normal, long)
- functions: single or double cup, steam dispenser for cappuccino and hot water, programmed on/off, automatic rinse function in on/off, pre-ground coffee option
- display indications: add water, add coffee, remove residue, descaling required, grind size and dose warning
- multilingual digital programmer + knobs
- features: front controls and knobs in Soft-Touch finish, drip tray, LED lighting, telescopic rails, 220 g coffee bean container, removable 1.8 l water tank
- pressure: 15 bar
- maximum absorbed power: 1.35 kW

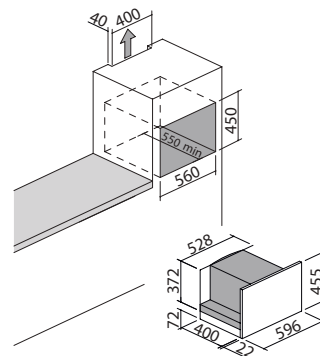

MATT BLACK STAINLESS STEEL

code **1CFEVEN**

SATIN STAINLESS STEEL

code **1CFEVS**

BLACK GLASS

code **1CFEVG**



ICON VACUUM SEALER DRAWER 60 cm built-in h. 15

Icon built-in vacuum sealer drawer
Touch Control

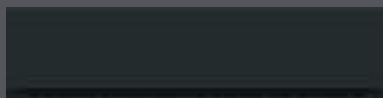

Exclusive



Steel

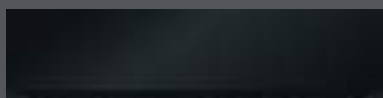

Glass

SISTEMA **FEEL**
Good



- functions: 3 levels of vacuum sealing in bag, 3 levels of sealing, 3 levels of vacuum sealing in a container, Chef function for marinating, ripening, cold infusion and extracting essential oils
- Touch control digital display
- motor: oil pump
- features: cover in tempered glass, bowl interior in stainless steel, push-pull opening
- equipment: adapter for container trays, kit of 50 food storage bags and 50 bags for cooking food, telescopic rails
- maximum absorbed power: 0.24 kW

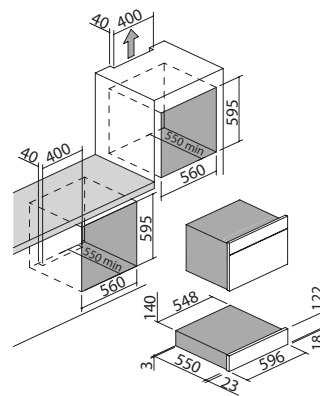

MATT BLACK STAINLESS STEEL

code **1CSEVEN**

SATIN STAINLESS STEEL

code **1CSEVS**

BLACK GLASS

code **1CSEVG**

Accessories:



57

code **1KS3**



ICON WARMING DRAWER 60 cm built-in h. 15

Icon built-in warming drawer

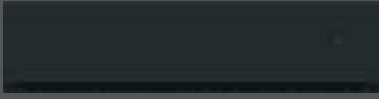

Exclusive



Steel

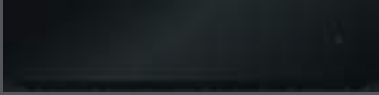

Glass



- warming plates, tableware, coffee cups
- keep warm function
- defrost function
- leavening
- adjustable temperature from 30 °C to 70 °C
- features: flat internal glass surface with non-slip mat, telescopic rails, push-pull opening, operating light, cool front panel
- maximum absorbed power: 0.4 kW

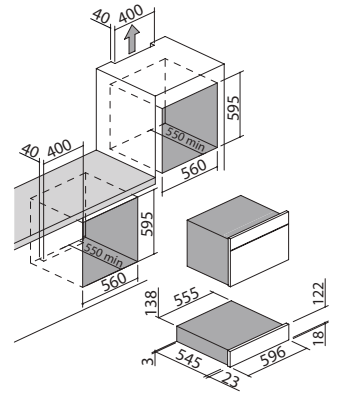

MATT BLACK STAINLESS STEEL

code **1CEEVEN**

SATIN STAINLESS STEEL

code **1CEEVS**

BLACK GLASS

code **1CEEVG**



ICON ONE OVEN

60 cm built-in

60 cm Icon One built-in oven
Multiprogram



Exclusive



Steel



Glass



NEW energy rating **A**

Accessories: **28** **79** **29** **80**



- 8 manual functions + rapid defrost function
- maximum temperature: 270 °C
- capacity: 66 litres
- electronic digital start/stop cooking programmer and timer
- features: front controls, knobs and handle in Soft-Touch finish, Easy Clean oven interior, extractable and removable door with triple heat-reflecting glass, Soft-Close hinges, tangential cooling fan, drop-down grill, 2 rear lights, side racks
- equipment: 1 deep Easy Clean enamelled steel drip tray, 1 Easy Clean enamelled steel drip tray, 1 steel rack
- safety devices: safety switch-off
- maximum absorbed power: 2.7 kW

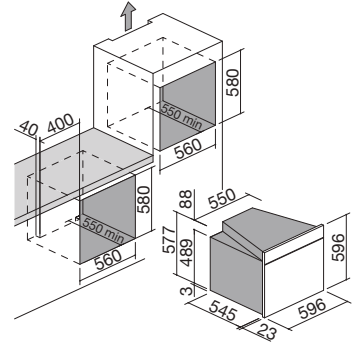

MATT BLACK STAINLESS STEEL

code **1FIOEPN**

SATIN STAINLESS STEEL

code **1FIOSP**

BLACK GLASS

code **1FIOGP**

Accessories:

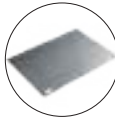

28

code **1PPI**

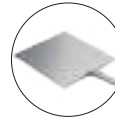

79

code **1PPZ**



29

code **1CG6**



80

code **1CFFA**



ICON X OVEN

75 cm built-in h. 60

75 cm Icon X built-in oven
Multiprogram



Exclusive



Steel



Glass



NEW energy rating **A**

Accessories: **28** **79** **80**



- 9 manual functions
- maximum temperature: 250 °C
- capacity: 89 litres
- electronic digital start/stop cooking programmer and timer
- features: front controls, knobs and handle in Soft-Touch finish, Easy Clean oven interior, extractable and removable door with triple heat-reflecting glass, Soft-Close hinges, tangential cooling fan, 2 rear lights, side racks
- equipment: 1 Easy Clean enamelled steel drip tray, 1 steel rack, 1 pair of telescopic oven rails, rotisserie
- safety devices: safety switch-off
- maximum absorbed power: 3.5 kW

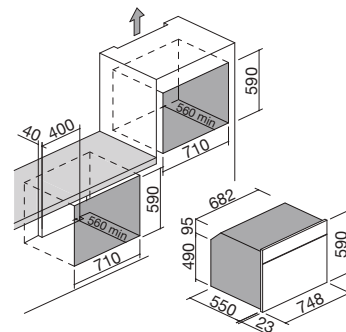

MATT BLACK STAINLESS STEEL	code 1FIXEPN
SATIN STAINLESS STEEL	code 1FIXSP
BLACK GLASS	code 1FIXGP

Accessories:

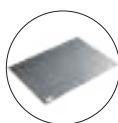

28
code **1PPI**

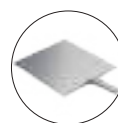

79
code **1PPZ**



80
code **1CFFA**



MICROWAVE

75 cm built-in h. 38

75 cm built-in microwave oven



Exclusive



Steel



NEW



- 6 cooking functions
- automatic programming for 8 types of food
- capacity: 25 litres
- features: stainless steel interior, glass inner door, double-glass side-opening door, internal light
- equipment: extractable turntable plate, raised removable grill rack
- safety devices: electronic safety lock
- maximum absorbed power: 1.45 kW

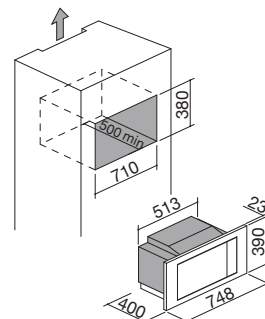

MATT BLACK STAINLESS STEEL/BLACK GLASS code 1MOXEN

SATIN STAINLESS STEEL/BLACK GLASS code 1MOXI



ICON XL OVEN

90 cm built-in h. 60

90 cm Icon XL built-in oven
Multiprogram



Exclusive



Steel



Glass



NEW energy rating **A**

Accessories: **28** **79** **80**



- 90x60 cm
- 8 manual functions
- maximum temperature: 250 °C
- capacity: 120 litres
- electronic digital start/stop cooking programmer and timer
- features: front controls, knobs and handle in Soft-Touch finish, extractable and removable door with triple heat-reflecting glass, Easy Clean oven interior, dark grey glass, Soft-Close hinges, tangential cooling fan, triple convection fan, 2 rear lights, side racks
- equipment: 1 Easy Clean enamelled steel drip tray, 1 steel rack, rotisserie
- safety devices: safety switch-off
- maximum absorbed power: 3.15 kW

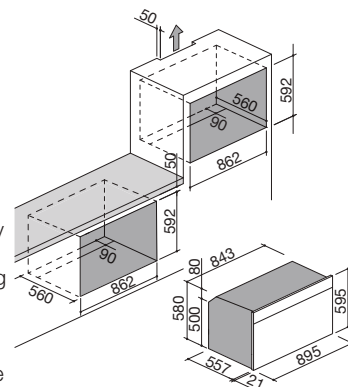

MATT BLACK STAINLESS STEEL

code **1FICN9EN**

SATIN STAINLESS STEEL

code **1FICN9EI**

DARK GREY BLACK GLASS

code **1FICN9E**

Accessories:

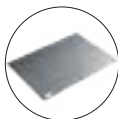

28
code **1PPI**

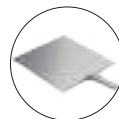

79
code **1PPZ**



80
code **1CFFA**



VELVET ADVANCE OVEN

60 cm built-in

60 cm Velvet Advance built-in oven
Touch Screen



Exclusive



Steel



Glass

Zefiro



NEW energy rating A

Accessories: 28 79 80



- Zefiro sanitisation system
- 13 manual functions
- 16 automatic cooking programs + Cleaning
- 30 customisable cooking programs
- Veggy mode
- maximum temperature: 250 °C
- capacity: 66 litres
- interactive multilingual touch screen features: handle in Soft-Touch finish, Easy Clean oven interior, extractable and removable door with triple heat-reflecting glass, dark grey glass, Soft-Close hinges, tangential cooling fan, drop-down grill, 2 internal lights, side racks
- equipment: 1 deep Easy Clean enamelled steel drip tray, 1 Easy Clean enamelled steel drip tray, 2 pairs of telescopic oven rails
- safety devices: safety switch-off, electronic child-safety lock
- maximum absorbed power: 2.7 kW

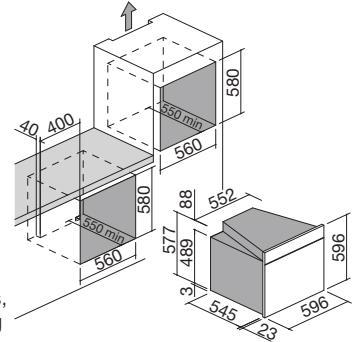

MATT BLACK STAINLESS STEEL

code 1FVAPEN

SATIN STAINLESS STEEL

code 1FVAPI

DARK GREY BLACK GLASS

code 1FVAPN

Accessories:

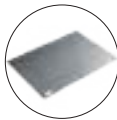

28

code 1PPI

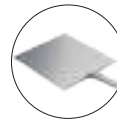

79

code 1PPZ



80

code 1CFFA



CITY ONE OVEN 60 cm built-in

60 cm City One built-in oven
Multiprogram



Steel



Glass



NEW energy rating **A**

Accessories: **28** **79** **29** **80**



- 8 manual functions + rapid defrost function
- maximum temperature: 270 °C
- capacity: 66 litres
- electronic digital start/stop cooking programmer and timer
- features: Easy Clean oven interior, extractable and removable door with triple heat-reflecting glass, Soft-Close hinges, tangential cooling fan, drop-down grill, 2 rear lights, side racks
- equipment: 1 deep Easy Clean enamelled steel drip tray, 1 Easy Clean enamelled steel drip tray, 1 steel rack
- maximum absorbed power: 2.7 kW

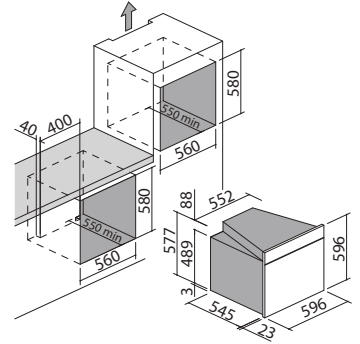

SATIN STAINLESS STEEL / BLACK GLASS code **1FCOPI**
BLACK GLASS code **1FCOPN**

Accessories:

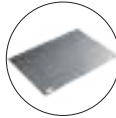

28
code **1PPI**

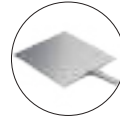

79
code **1PPZ**



29
code **1CG6**



80
code **1CFFA**



CITY ONE OVEN

60 cm built-in

60 cm City One built-in oven
Multifunction



Steel



NEW energy rating **A**

Accessories: **28** **79** **29** **80**



- 8 manual functions + rapid defrost function
- maximum temperature: 270 °C
- capacity: 66 litres
- 90' mechanical timer with buzzer
- features: Easy Clean oven interior, extractable and removable door with triple heat-reflecting glass, Soft-Close hinges, tangential cooling fan, drop-down grill, 2 internal lights, side racks
- equipment: 1 deep Easy Clean enamelled steel drip tray, 1 Easy Clean enamelled steel drip tray, 1 steel rack
- maximum absorbed power: 2.7 kW

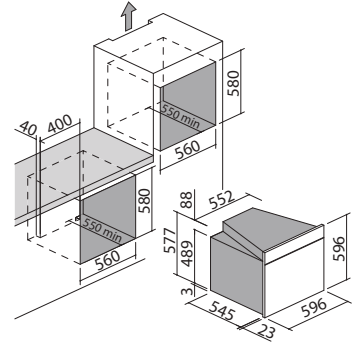

SATIN STAINLESS STEEL / BLACK GLASS code **1FCOMI**

Accessories:

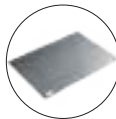

28

code **1PPI**

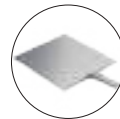

79

code **1PPZ**



29

code **1CG6**



80

code **1CFFA**



CITY STEEL OVEN

90 cm built-in h. 48

90 cm City Steel built-in oven
Multiprogram



energy rating **A**

Accessories: **28 33 79 80**

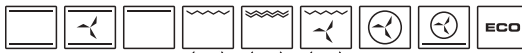

- 9 manual functions
- maximum temperature: 250 °C
- capacity: 89 litres
- electronic digital start/stop cooking programmer and timer
- features: Easy Clean oven interior, extractable and removable door with triple heat-reflecting glass, tangential cooling fan, 2 rear lights, side racks
- equipment: rotisserie, 1 deep Easy Clean enamelled steel drip tray, 2 steel racks
- maximum absorbed power: 3.5 kW

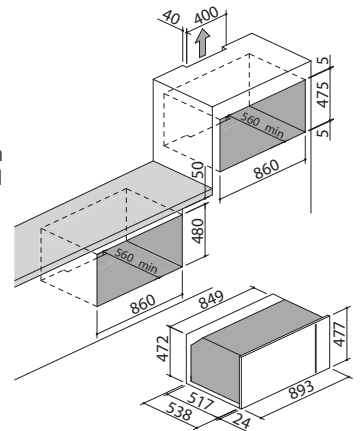

SATIN STAINLESS STEEL / BLACK GLASS code **1FCYP9**

Accessories:

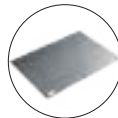

28

code **1PPI**

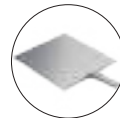

33

code **1PPZ**



79

code **1CG9**



80

code **1CFFA**

UNIQUE ONE OVEN

60 cm built-in

60 cm Unique One built-in oven
Multifunction



NEW energy rating **A**

Accessories: **28 79 29 80**



- 8 manual functions + rapid defrost function
- maximum temperature: 250 °C
- capacity: 66 litres
- 90' mechanical timer with buzzer
- features: Easy Clean oven interior, extractable and removable door with triple heat-reflecting glass, tangential cooling fan, drop-down grill, 2 internal lights, side racks
- equipment: 1 deep Easy Clean enamelled steel drip tray, 1 Easy Clean enamelled steel drip tray, 1 steel rack
- maximum absorbed power: 2.7 kW

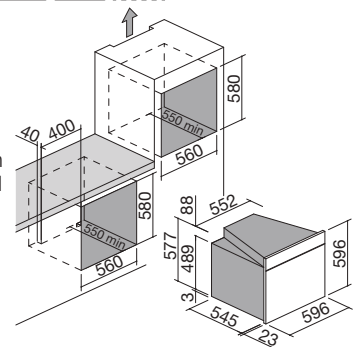

VINTAGE STAINLESS STEEL

code **1FUOM**

Accessories:

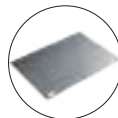

28

code **1PPI**

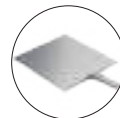

79

code **1PPZ**



29

code **1CG6**



80

code **1CFFA**

OFFICINA ADVANCE OVENS

60 cm built-in

60 cm Officina Advance built-in oven
Multiprogram



Steel



60 cm Officina Advance built-in oven
Multifunction



Steel



energy rating **A**

Accessories: **80**



- 8 manual functions + rapid defrost function
- maximum temperature: 250 °C
- capacity: 66 litres
- electronic digital start/stop cooking programmer and timer
- features: Easy Clean oven interior, extractable and removable door with triple heat-reflecting glass, tangential cooling fan, 1 rear light
- equipment: 1 deep Easy Clean enamelled steel drip tray, 1 Easy Clean enamelled steel drip tray, 1 steel rack
- maximum absorbed power: 2.7 kW

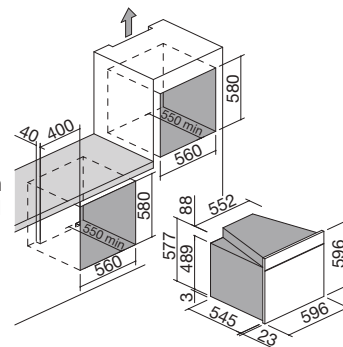

SATIN STAINLESS STEEL

code **1FOAP**

energy rating **A**

Accessories: **80**



- 8 manual functions + rapid defrost function
- maximum temperature: 250 °C
- capacity: 66 litres
- 90' mechanical timer with buzzer
- features: Easy Clean oven interior, extractable and removable door with triple heat-reflecting glass, tangential cooling fan, 1 rear light
- equipment: 1 deep Easy Clean enamelled steel drip tray, 1 Easy Clean enamelled steel drip tray, 1 steel rack
- maximum absorbed power: 2.7 kW

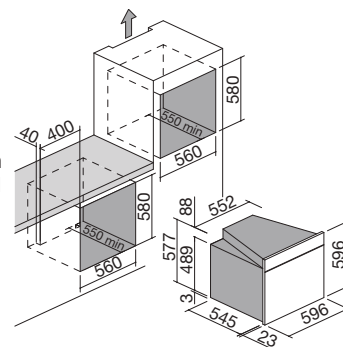

SATIN STAINLESS STEEL

code **1FOAM**

Accessories:



80

code **1CFFA**

MICROWAVE

60 cm built-in h. 38

Built-in microwave oven



Exclusive



Steel



Vintage



Glass



- 6 cooking functions
- automatic programming for 8 types of food
- capacity: 25 litres
- features: stainless steel interior, glass inner door, double-glass side-opening door, internal light
- equipment: extractable turntable plate, raised removable grill rack
- safety devices: electronic safety lock
- maximum absorbed power: 1.45 kW

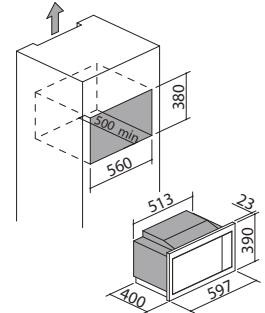

- MATT BLACK STAINLESS STEEL / BLACK GLASS** code **1MOEN**
- SATIN STAINLESS STEEL / BLACK GLASS** code **1MOI**
- VINTAGE STAINLESS STEEL / BLACK GLASS** code **1MOIV**
- BLACK GLASS** code **1MOGN**





VELVET ADVANCE



CITY ONE



UNIQUE ONE



OFFICINA ADVANCE

LAB EVOLUTION HOBS

flat edge built-in and flush

90 cm Lab Evolution built-in and flush hob
2 gas burners + Flat Eco-Design double ring



120 cm Lab Evolution built-in and flush hob
3 gas burners + Flat Eco-Design double ring

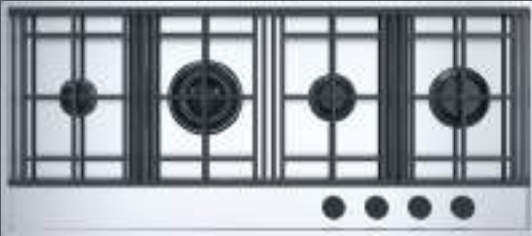

FEB FT

- extra-thick AISI 304 stainless steel
- controls: Flat knobs in Soft-Touch finish
- Flat Eco-Design burners
- cast iron pan supports
- 86x49 cm cut out flush-top: see website

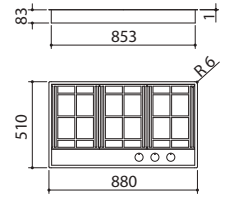

Burner power:

- 1 semi-rapid: 1.75 kW
- 1 rapid: 3 kW
- 1 double ring 4 kW

SATIN STAINLESS STEEL

code 1PLE2D

FEB FT

- extra-thick AISI 304 stainless steel
- controls: Flat knobs in Soft-Touch finish
- Flat Eco-Design burners
- cast iron pan supports
- 114x49 cm cut out flush-top: see website

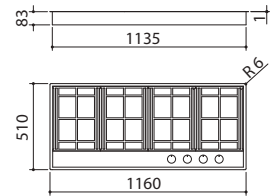

Burner power:

- 1 auxiliary: 1 kW
- 1 semi-rapid: 1.75 kW
- 1 rapid: 3 kW
- 1 double ring 4 kW

SATIN STAINLESS STEEL

code 1PLE3D

Standard equipment: automatic ignition, safety valve, fixing clips.



LAB HOBS

flat edge built-in and flush

65 cm Lab built-in and flush hob
4 gas burners



90 cm Lab built-in and flush hob
4 gas burners + double ring



90 cm Lab built-in and flush hob
2 gas burners + double ring



120 cm Lab built-in and flush hob
3 gas burners + double ring



- extra-thick AISI 304 stainless steel
- cast iron pan supports
- controls: integrated side top
- 59.5x49 cm cut out
flush-top: see website

Burner power:

- 1 auxiliary: 1 kW
- 2 semi-rapid: 1.75 kW
- 1 rapid: 2.5 kW

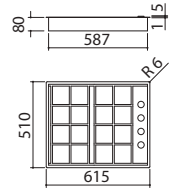

SATIN STAINLESS STEEL

code 1PLB4



Accessories: **35**

- extra-thick AISI 304 stainless steel
- cast iron pan supports
- controls: integrated side top
- 85x49 cm cut out
flush-top: see website

Burner power:

- 1 auxiliary: 1 kW
- 2 semi-rapid: 1.75 kW
- 1 rapid: 2.5 kW
- 1 double ring 3.5 kW

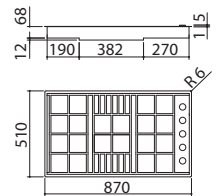

SATIN STAINLESS STEEL

code 1PLB5



Accessories: **35**

- extra-thick AISI 304 stainless steel
- cast iron pan supports
- controls: integrated side top
- 87.5x43.5 cm cut out
flush-top: see website

Burner power:

- 1 auxiliary: 1 kW
- 1 semi-rapid: 1.75 kW
- 1 double ring 3.5 kW

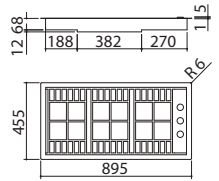

SATIN STAINLESS STEEL

code 1PLB2T



Accessories: **35**

- extra-thick AISI 304 stainless steel
- cast iron pan supports
- controls: integrated side top
- 113x43.5 cm cut out
flush-top: see website

Burner power:

- 1 auxiliary: 1 kW
- 1 semi-rapid: 1.75 kW
- 1 rapid: 3 kW
- 1 double ring 3.5 kW

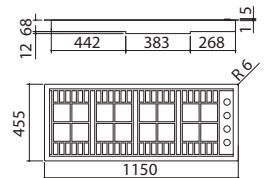

SATIN STAINLESS STEEL

code 1PLB3T

Accessories:



35

code 1RWJ

Standard equipment: automatic ignition, safety valve, eco-flame, fixing clips.

MOOD HOB

4 mm stainless steel edge built-in

65 cm Mood built-in hob

3 gas burners + Flat Eco-Design double ring



75 cm Mood built-in hob for 60 cm base

4 gas burners + Flat Eco-Design double ring



75 cm Mood built-in hob

4 gas burners + Flat Eco-Design double ring



90 cm Mood built-in hob

4 gas burners + Flat Eco-Design double ring



EB4

- 4 mm thick AISI 304 stainless steel
- Flat Eco-Design burners
- cast iron pan supports
- 56x48 cm cut out

Burner power:

- 1 auxiliary: 1 kW
- 1 semi-rapid: 1.75 kW
- 1 rapid: 3 kW
- 1 double ring 4 kW

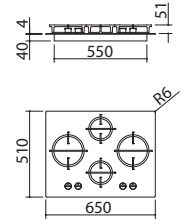

4 mm SATIN STAINLESS STEEL

code 1PMD64

EB4

- 4 mm thick AISI 304 stainless steel
- Flat Eco-Design burners
- cast iron pan supports
- 56x48 cm cut out for 60 cm base

Burner power:

- 1 auxiliary: 1 kW
- 2 semi-rapid: 1.75 kW
- 1 rapid: 3 kW
- 1 double ring 4 kW

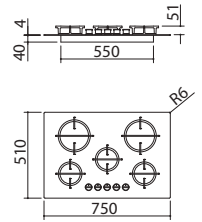

4 mm SATIN STAINLESS STEEL

code 1PMD70

EB4

- 4 mm thick AISI 304 stainless steel
- Flat Eco-Design burners
- cast iron pan supports
- 72x48 cm cut out

Burner power:

- 1 auxiliary: 1 kW
- 2 semi-rapid: 1.75 kW
- 1 rapid: 3 kW
- 1 double ring 4 kW

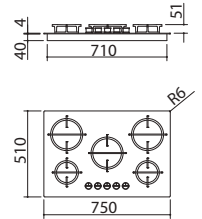

4 mm SATIN STAINLESS STEEL

code 1PMD75

EB4

- 4 mm thick AISI 304 stainless steel
- Flat Eco-Design burners
- cast iron pan supports
- 83x48 cm cut out

Burner power:

- 1 auxiliary: 1 kW
- 2 semi-rapid: 1.75 kW
- 1 rapid: 3 kW
- 1 double ring 4 kW

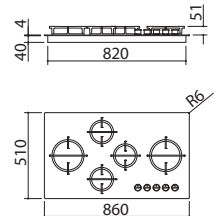

4 mm SATIN STAINLESS STEEL

code 1PMD95

MOOD HOB

4 mm stainless steel edge built-in

110 cm Mood built-in hob

3 gas burners + Flat Eco-Design double ring



EB4

- 4 mm thick AISI 304 stainless steel
- Flat Eco-Design burners
- cast iron pan supports
- 107x37 cm cut out

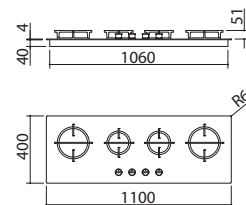

Burner power:

- 1 auxiliary: 1 kW
- 1 semi-rapid: 1.75 kW
- 1 rapid: 3 kW
- 1 double ring 4 kW

4 mm SATIN STAINLESS STEEL

code 1PMD104

Standard equipment: automatic ignition, safety valve, fixing clips, seal.



MOOD HOBS

4 mm white glass ceramic edge built-in

75 cm Mood built-in hob for 60 cm base
4 gas burners + Flat Eco-Design double ring



90 cm Mood built-in hob
4 gas burners + Flat Eco-Design double ring



FGB

- 4 mm thick glass ceramic
- Flat Eco-Design burners
- cast iron pan supports
- 56x48 cm cut out for 60 cm base

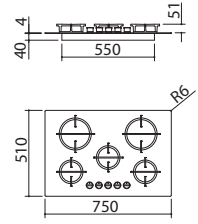

Burner power:

- 1 auxiliary: 1 kW
- 2 semi-rapid: 1.75 kW
- 1 rapid: 3 kW
- 1 double ring 4 kW

4 mm WHITE GLASS CERAMIC

code **1PMD70B**

FGB

- 4 mm thick glass ceramic
- Flat Eco-Design burners
- cast iron pan supports
- 83x48 cm cut out

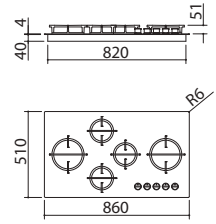

Burner power:

- 1 auxiliary: 1 kW
- 2 semi-rapid: 1.75 kW
- 1 rapid: 3 kW
- 1 double ring 4 kW

4 mm WHITE GLASS CERAMIC

code **1PMD95B**

Standard equipment: automatic ignition, safety valve, fixing clips, seal.



MOOD HOBS

4 mm black glass ceramic edge built-in

65 cm Mood built-in hob

3 gas burners + Flat Eco-Design double ring



75 cm Mood built-in hob for 60 cm base

4 gas burners + Flat Eco-Design double ring



90 cm Mood built-in hob

4 gas burners + Flat Eco-Design double ring



110 cm Mood built-in hob

3 gas burners + Flat Eco-Design double ring



FGB

- 4 mm thick glass ceramic
- Flat Eco-Design burners
- cast iron pan supports
- 56x48 cm cut out

Burner power:

- 1 auxiliary: 1 kW
- 1 semi-rapid: 1.75 kW
- 1 rapid: 3 kW
- 1 double ring 4 kW

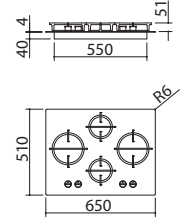

4 mm BLACK GLASS CERAMIC

code 1PMD64N

FGB

- 4 mm thick glass ceramic
- Flat Eco-Design burners
- cast iron pan supports
- 56x48 cm cut out for 60 cm base

Burner power:

- 1 auxiliary: 1 kW
- 2 semi-rapid: 1.75 kW
- 1 rapid: 3 kW
- 1 double ring 4 kW

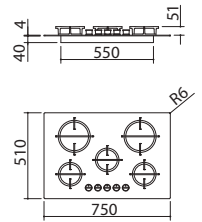

4 mm BLACK GLASS CERAMIC

code 1PMD70N

FGB

- 4 mm thick glass ceramic
- Flat Eco-Design burners
- cast iron pan supports
- 83x48 cm cut out

Burner power:

- 1 auxiliary: 1 kW
- 2 semi-rapid: 1.75 kW
- 1 rapid: 3 kW
- 1 double ring 4 kW

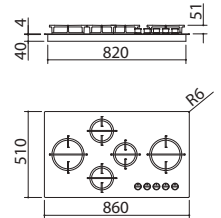

4 mm BLACK GLASS CERAMIC

code 1PMD95N

FGB

- 4 mm thick glass ceramic
- Flat Eco-Design burners
- cast iron pan supports
- 107x37 cm cut out

Burner power:

- 1 auxiliary: 1 kW
- 1 semi-rapid: 1.75 kW
- 1 rapid: 3 kW
- 1 double ring 4 kW

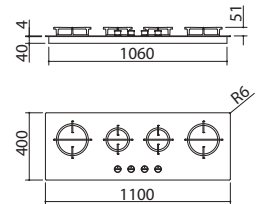

4 mm BLACK GLASS CERAMIC

code 1PMD104N

Standard equipment: automatic ignition, safety valve, fixing clips, seal.

B_FREE HOBS

square edge built-in

36 cm B_Free built-in hob

double ring 5 kW



36 cm B_Free built-in hob

1 gas burner + Chef double ring



36 cm B_Free built-in hob

teppanyaki



36 cm B_Free built-in hob

barbecue



SQEB

Accessories: 35

- extra-thick AISI 304 stainless steel
- cast iron pan support
- burner with dual control
- 34x49 cm cut out

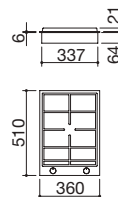

Burner power:

- 1 Chef double ring: 5 kW
(central 0.8 kW and ring 4.2 kW)

SATIN STAINLESS STEEL

code 1PBF1

SQEB

- extra-thick AISI 304 stainless steel
- cast iron pan support
- 34x49 cm cut out

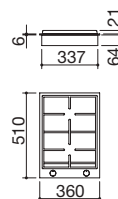

Burner power:

- 1 semi-rapid: 1.75 kW
- 1 Chef double ring: 3.5 kW

SATIN STAINLESS STEEL

code 1PBF2

SQEB NEW

- extra-thick AISI 304 stainless steel
- 6 mm AISI 304 stainless steel single hotplate
- thermostat
- 2 cooking zones
- electronic temperature control from 50 °C to 270 °C
- hotplate activation indicator and thermostat
- maximum absorbed power: 1 kW
- 34x49 cm cut out

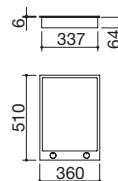

SATIN STAINLESS STEEL

code 1PBFTK1

SQEB

- extra-thick AISI 304 stainless steel
- barbecue with electric element
- cast iron grid
- lava stone to absorb cooking liquids
- removable tray
- settings 0 to 9
- heating element activation indicator
- maximum absorbed power: 1.75 kW
- 34x49 cm cut out

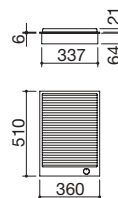

SATIN STAINLESS STEEL

code 1PFBFQ

B_FREE HOBS

square edge built-in

60 cm B_Free built-in hob

3 gas burner + Chef double ring



70 cm B_Free built-in hob

2 gas burners + 2 Chef double rings

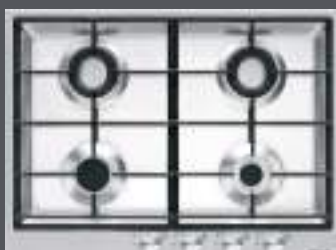

90 cm B_Free built-in hob

3 gas burners + Chef double ring + double ring 4 kW



100 cm B_Free built-in hob

2 gas burners + 2 Chef double rings

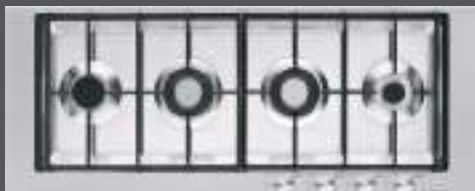

SQEB

- extra-thick AISI 304 stainless steel
- cast iron pan supports
- 56x49 cm cut out

Burner power:

- 1 auxiliary: 1 kW
- 1 semi-rapid: 1.75 kW
- 1 rapid: 3 kW
- 1 Chef double ring: 3.5 kW

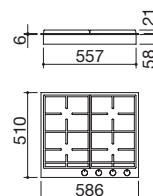

SATIN STAINLESS STEEL

code 1PBF64

SQEB

- extra-thick AISI 304 stainless steel
- cast iron pan supports
- 66.5x49 cm cut out

Burner power:

- 1 auxiliary: 1 kW
- 1 semi-rapid: 1.75 kW
- 2 Chef double ring: 3.5 kW

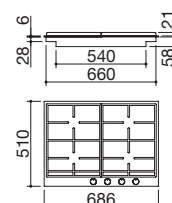

SATIN STAINLESS STEEL

code 1PBF74

SQEB

Accessories: 35

- extra-thick AISI 304 stainless steel
- cast iron pan supports
- burner with dual control
- 84x49 cm cut out

Burner power:

- 1 auxiliary: 1 kW
- 1 semi-rapid: 1.75 kW
- 1 rapid: 3 kW
- 1 Chef double ring: 3.5 kW
- 1 double ring 4 kW

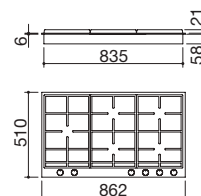

SATIN STAINLESS STEEL

code 1PBF95

SQEB

Accessories: 35

- extra-thick AISI 304 stainless steel
- cast iron pan supports
- 98x38 cm cut out

Burner power

- 1 auxiliary: 1 kW
- 1 semi-rapid: 1.75 kW
- 2 Chef double ring: 3.5 kW

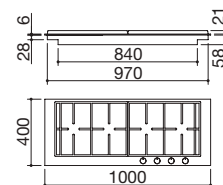

SATIN STAINLESS STEEL

code 1PBF104

Accessories:



35

code 1RWJ

Gas hobs standard equipment: automatic ignition, safety valve, eco-flame, fixing clips, seal.

Electric hobs standard equipment: fixing clips, seal.

UNIQUE HOBS

lowered edge built-in

60 cm Unique built-in hob

3 gas burners + triple ring



70 cm Unique built-in hob

4 gas burners + triple ring



90 cm Unique built-in hob

4 gas burners + triple ring



100 cm Unique built-in hob

2 gas burners + 2 gas fish burner + triple ring



LEB

Accessories: 35

- extra-thick AISI 304 stainless steel
- cast iron pan supports
- 56x48 cm cut out

Burner power:

- 1 auxiliary: 1 kW
- 2 semi-rapid: 1.75 kW
- 1 triple ring 3.8 kW

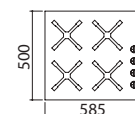

VINTAGE STAINLESS STEEL

code 1PUN64

LEB

Accessories: 35

- extra-thick AISI 304 stainless steel
- cast iron pan supports
- 68x48 cm cut out

Burner power:

- 1 auxiliary: 1 kW
- 2 semi-rapid: 1.75 kW
- 1 rapid: 3 kW
- 1 triple ring 3.8 kW

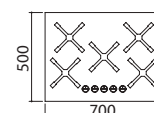
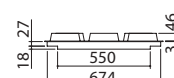

VINTAGE STAINLESS STEEL

code 1PUN75

LEB

Accessories: 35

- extra-thick AISI 304 stainless steel
- cast iron pan supports
- 84x48 cm cut out

Burner power:

- 1 auxiliary: 1 kW
- 2 semi-rapid: 1.75 kW
- 1 rapid: 3 kW
- 1 triple ring 3.8 kW

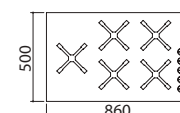

VINTAGE STAINLESS STEEL

code 1PUN95

LEB

Accessories: 35

- extra-thick AISI 304 stainless steel
- cast iron pan supports
- 98x43 cm cut out

Burner power:

- 2 auxiliary: 1 kW
- 1 semi-rapid: 1.75 kW
- 1 rapid: 3 kW
- 1 triple ring 3.8 kW

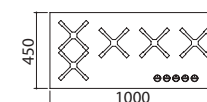
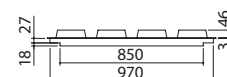

VINTAGE STAINLESS STEEL

code 1PUN105

Accessories:



35
code 1RWJ

Standard equipment: automatic ignition, safety valve, eco-flame, fixing clips, seal.

LAB



MOOD



B_FREE



UNIQUE



SELECT PLUS HOBS

lowered edge built-in

60 cm Select Plus built-in hob

3 gas burners + triple ring



70 cm Select Plus built-in hob

4 gas burners + triple ring



90 cm Select Plus built-in hob

4 gas burners + triple ring



100 cm Select Plus built-in hob

2 gas burners + 2 gas fish burner + triple ring



LEB

Accessories: 35

- extra-thick AISI 304 stainless steel
- cast iron pan supports
- 56x48 cm cut out



Burner power:

- 1 auxiliary: 1 kW
- 2 semi-rapid: 1.75 kW
- 1 triple ring 3.8 kW

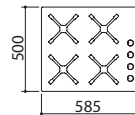

SATIN STAINLESS STEEL

code 1PSP64

LEB

Accessories: 35

- extra-thick AISI 304 stainless steel
- cast iron pan supports
- 68x48 cm cut out

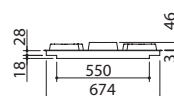

Burner power:

- 1 auxiliary: 1 kW
- 2 semi-rapid: 1.75 kW
- 1 rapid: 3 kW
- 1 triple ring 3.8 kW

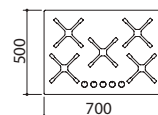

SATIN STAINLESS STEEL

code 1PSP75

LEB

Accessories: 35

- extra-thick AISI 304 stainless steel
- cast iron pan supports
- 84x48 cm cut out



Burner power:

- 1 auxiliary: 1 kW
- 2 semi-rapid: 1.75 kW
- 1 rapid: 3 kW
- 1 triple ring 3.8 kW

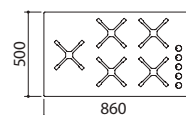

SATIN STAINLESS STEEL

code 1PSP95

LEB

Accessories: 35

- extra-thick AISI 304 stainless steel
- cast iron pan supports
- 98x43 cm cut out

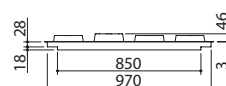

Burner power:

- 2 auxiliary: 1 kW
- 1 semi-rapid: 1.75 kW
- 1 rapid: 3 kW
- 1 triple ring 3.8 kW

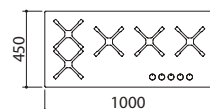

SATIN STAINLESS STEEL

code 1PSP105

Accessories:



35

code 1RWJ

Standard equipment: automatic ignition, safety valve, eco-flame, fixing clips, seal.

OFFICINA HOBS

flat edge built-in and flush

80 cm Officina built-in and flush hob
4 gas burners + double ring



90 cm Officina built-in and flush hob
4 gas burners + double ring

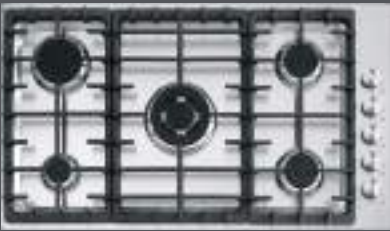

LEB FT

Accessories: 35

- extra-thick AISI 304 stainless steel
- cast iron pan supports
- 78x48 cm cut out
flush-top: see website

Burner power:

- 1 auxiliary: 1 kW
- 2 semi-rapid: 1.75 kW
- 1 rapid: 3 kW
- 1 double ring 3.5 kW

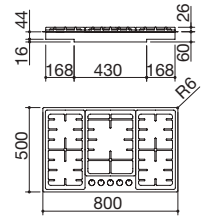

SATIN STAINLESS STEEL

code 1POF80

LEB FT

Accessories: 35

- extra-thick AISI 304 stainless steel
- cast iron pan supports
- 85x48 cm cut out
flush-top: see website

Burner power:

- 1 auxiliary: 1 kW
- 2 semi-rapid: 1.75 kW
- 1 rapid: 3 kW
- 1 double ring 3.5 kW

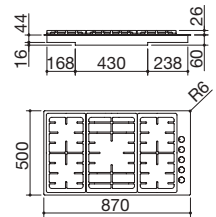

SATIN STAINLESS STEEL

code 1POF90

Accessories:



35

code 1RWJ

Standard equipment: automatic ignition, safety valve, eco-flame, fixing clips.

OFFICINA
MADE TO MEASURE version

Visit the website
www.barazzasrl.it



ICON INDUCTION HOB

flat glass edge built-in and flush

90 cm Icon built-in and flush hob
5 induction zones



FGB FT NEW

Accessories: 74

- Touch screen controls
- functions: power management, automatic functions (Melt, Warm), Bridge for LH zones, automatic pan recognition, Booster, automatic preheating, selective pan detection, pause/reminder function, independent cooking end timers, keep warm
- safety devices: electronic child-safety lock, residual heat indicator, overflow alarm, safety switch-off
- minimum pan diameter: ø 90 mm - ø 110 mm
- adjustable power levels: 2.2-2.3-2.4...7.0-7.1-7.2 kW
- maximum absorbed power: 7.2 kW
- 87x49 cm cut out flush-top: see website

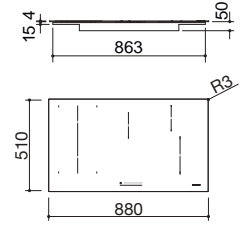

Induction zone power:

- 2 zones ø 145 mm 1.2-1.8 kW (*)
 - 1 zone ø 210 mm 2.2-3.6 kW (*)
 - 2 oval zones 2.2-3.6 kW (*)
- (*) with Booster function

4 mm BLACK GLASS CERAMIC

code 1PIDI9

Accessories:

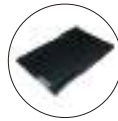

74

code 1BID

Standard equipment: integrated clips for quick attachment, seal.



LAB EVOLUTION INDUCTION HOBS

flat edge built-in and flush

90 cm Lab Evolution built-in and flush hob
3 induction zones



120 cm Lab Evolution built-in and flush hob
4 induction zones



FEB FT

Accessories: 74

- extra-thick AISI 304 stainless steel
- controls: Flat knobs in Soft-Touch finish
- functions: power management, Bridge, Booster, selective pan detection, automatic preheating, keep warm
- safety devices: electronic child-safety lock, residual heat indicator, overflow alarm, safety switch-off
- minimum pan diameter: \varnothing 110 mm
- adjustable power levels: 1.6 - 2.0 - 2.8 - 3.5 - 4.3 - 5 - 5.5 - 6 - 6.7 kW
- maximum absorbed power: 6.7 kW
- 86x49 cm cut out flush-top: see website

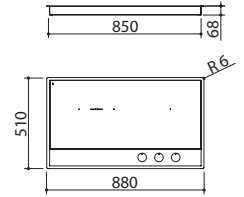

Induction zone power:

- 3 Octa zones: 2.1-3 kW (*)
- (*) with Booster function

BLACK GLASS CERAMIC/SATIN STAINLESS STEEL code 1PLE91D

FEB FT

Accessories: 74

- extra-thick AISI 304 stainless steel
- controls: Flat knobs in Soft-Touch finish
- functions: power management, Bridge, Booster, selective pan detection, automatic preheating, keep warm
- safety devices: electronic child-safety lock, residual heat indicator, overflow alarm, safety switch-off
- minimum pan diameter: \varnothing 110 mm
- adjustable power levels: 1.6 - 2.0 - 2.8 - 3.5 - 4.3 - 5 - 5.5 - 6 - 7.4 kW
- maximum absorbed power: 7.4 kW
- 114x49 cm cut out flush-top: see website

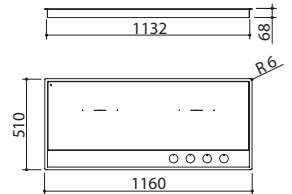

Induction zone power:

- 4 Octa zones: 2.1-3 kW (*)
- (*) with Booster function

BLACK GLASS CERAMIC/SATIN STAINLESS STEEL code 1PLE121D

Accessories:



74

code 1B1D

Standard equipment: fixing clips.



ZERO ADVANCE INDUCTION HOB WITH INTEGRATED COOKER HOOD

flat glass edge built-in and flush

80 cm Zero Advance built-in and flush hob integrated cooker hood



FGB FT NEW

Accessories: 74 75 76 77 78

INDUCTION

- Touch controls
functions: power management, Bridge, automatic pan recognition, Booster, selective pan detection, pause/reminder function, cooking end timer 1-600', minute minder, automatic preheating, keep warm
- safety devices: electronic child-safety lock, residual heat indicator, overflow alarm, safety switch-off
- minimum pan diameter: \varnothing 110 mm
adjustable power levels:
2.8 – 3.5 – 4.5 – 7.4 kW
- maximum absorbed power: 7.4 kW

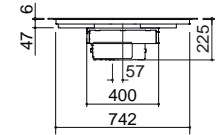
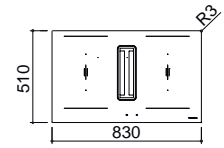

COOKER HOOD

- speeds: 8 + 2 intensive
- automatic extraction mode
- nominal air flow: 800 m³/h
- pressure: 497 Pa
- noise level: 63-69 Lw (dBA)
- filter: black aluminium
- energy rating A+
- maximum absorbed power: 0.22 kW
- rear smoke outlet
- optional filter extraction
- extractor outlet hole: 221x91 r.12 mm

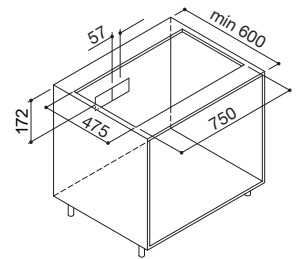

Induction zone power:

- 4 Octa zones: 2.1 – 3 (*) – 3.7 (**) kW
(*) with Booster function
(**) with Bridge function

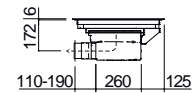

- 75x47.5 cm cut out
flush-top: see website

BLACK GLASS CERAMIC WITH BLACK EXTRACTOR GRID

code 1PZA8N

Accessories:

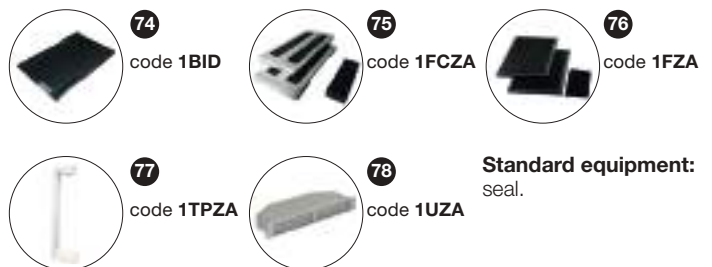

Standard equipment:
seal.



SPACE INDUCTION HOB

flat glass edge built-in and flush

90 cm Space built-in and flush hob
5 induction zones



FGB FT

Accessories: 74

- Touch controls with multi-slider
- functions: automatic cooking at three levels (Warming, Melt, Simmer), Bridge, automatic pan recognition, Booster, selective pan detection, pause/reminder function, cooking end timer 1-99'
- safety devices: electronic child-safety lock, residual heat indicator, overflow alarm, safety switch-off
- minimum pan diameter: \varnothing 125 mm
- maximum absorbed power: 11.1 kW
- 86x49 cm cut out
flush-top: see website

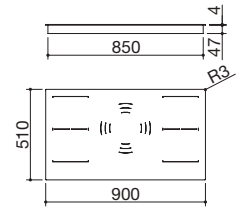

Induction zone power:

- 1 zone \varnothing 260 mm: 2.6-5.5 kW (*)
 - 4 Octa zones: 2.1-3.7 kW (*)
- (*) with Booster function

4 mm BLACK GLASS CERAMIC

code 1PIDS90N

Accessories:

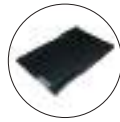

74

code 1BID

Standard equipment: integrated clips for quick attachment, seal.



KASAI SPACE INDUCTION HOB built-in edge 40 mm

90 cm Kasai Space built-in hob
5 induction zones



Accessories: **74**

- perimeter frame h 40 mm in 4 mm thick AISI stainless steel
- Touch control with multi-slider
- functions: automatic cooking at three levels (Warming, Melt, Simmer), Bridge, automatic pan recognition, Booster, selective pan detection, pause/reminder function, cooking end timer 1-99'
- safety devices: electronic child-safety lock, residual heat indicator, overflow alarm, safety switch-off
- minimum pan diameter: \varnothing 125 mm
- maximum absorbed power: 11.1 kW
- 86x49 cm cut out

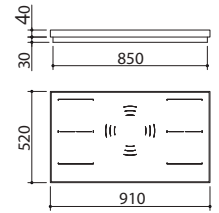

Induction zone power:

- 1 zone \varnothing 260 mm: 2.6-5.5 kW (*)
- 4 Octa zones: 2.1-3.7 kW (*)

(*) with Booster function

BLACK GLASS CERAMIC

code **1PKS90N**

Accessories:



74

code **1BID**

Standard equipment: fixing clips, seal.



CITY INDUCTION HOBS

flat glass edge built-in and flush

30 cm City built-in and flush hob

2 induction zones



60 cm City built-in and flush hob

4 induction zones

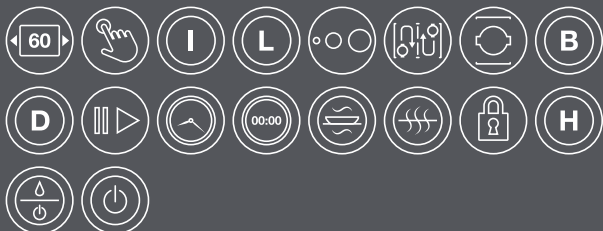

FGB FT

Accessories: 74

- Touch controls
- functions: power management, Chef Cook, Bridge, automatic pan recognition, Booster, selective pan detection, pause/reminder function, cooking end timer 1-600', minute minder, automatic preheating, keep warm
- safety devices: electronic child-safety lock, residual heat indicator, overflow alarm, safety switch-off
- minimum pan diameter: \varnothing 110 mm
- adjustable power levels: 1.4 - 1.5 - 1.6 - ... - 3.5 - 3.6 - 3.7 kW
- maximum absorbed power: 3.7 kW
- 28x49 cm cut out flush-top: see website

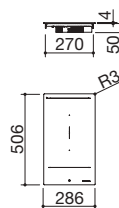

Induction zone power:

- 2 Octa zones: 2.1-3 kW (*)
- (*) with Booster function

4 mm BLACK GLASS CERAMIC

code 1PIDC30N

FGB FT

Accessories: 74

- Touch controls
- functions: power management, Chef Cook, Bridge, automatic pan recognition, Booster, selective pan detection, pause/reminder function, cooking end timer 1-600', minute minder, automatic preheating, keep warm
- safety devices: electronic child-safety lock, residual heat indicator, overflow alarm, safety switch-off
- minimum pan diameter: \varnothing 110 mm
- adjustable power levels: 1.4 - 1.5 - 1.6 - ... - 7.2 - 7.3 - 7.4 kW
- maximum absorbed power: 7.4 kW
- 56x49 cm cut out flush-top: see website

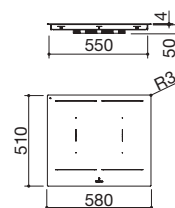

Induction zone power:

- 4 Octa zones: 2.1-3 kW (*)
- (*) with Booster function

4 mm BLACK GLASS CERAMIC

code 1PIDC60N



CITY INDUCTION HOBS

flat glass edge built-in and flush

75 cm City built-in and flush hob

4 induction zones



80 cm City built-in and flush hob

4 induction zones



90 cm City built-in and flush hob

3 induction zones

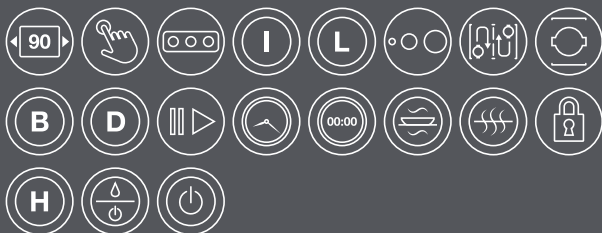

FGB FT NEW

Accessories: 74

- Touch controls
- functions: power management, Chef Cook, Bridge, automatic pan recognition, Booster, selective pan detection, pause/reminder function, cooking end timer 1-600', minute minder, automatic preheating, keep warm
- safety devices: electronic child-safety lock, residual heat indicator, overflow alarm, safety switch-off
- minimum pan diameter: \varnothing 110 mm
- adjustable power levels: 1.4 - 1.5 - 1.6 - ... - 7.2 - 7.3 - 7.4 kW
- maximum absorbed power: 7.4 kW
- 70X49 cm cut out
flush-top: see website

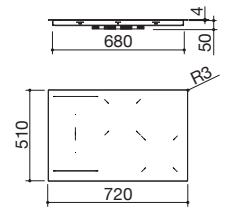

Induction zone power:

- 2 zones \varnothing 200 mm: 2.3-3 kW (*)
 - 2 Octa zones: 2.1-3 kW (*)
- (*) with Booster function

4 mm BLACK GLASS CERAMIC

code 1PIDC75N

FGB FT

- Touch controls
- functions: power management, automatic pan recognition, Booster, selective pan detection, pause/reminder function, cooking end timer 1-600', minute minder, automatic preheating, keep warm
- safety devices: electronic child-safety lock, residual heat indicator, overflow alarm, safety switch-off
- minimum pan diameter: \varnothing 90 mm
- adjustable power levels: 1.4 - 1.5 - 1.6 - ... - 7.2 - 7.3 - 7.4 kW
- maximum absorbed power: 7.4 kW
- 76x49 cm cut out
flush-top: see website

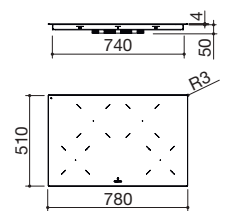

Induction zone power:

- 2 zones \varnothing 200 mm: 2.3-3 kW (*)
 - 2 zones \varnothing 160 mm: 1.4-2.1 kW (*)
- (*) with Booster function

4 mm BLACK GLASS CERAMIC

code 1PIDC80N

FGB FT

Accessories: 74

- Touch controls
- functions: power management, Chef Cook, Bridge, automatic pan recognition, Booster, selective pan detection, pause/reminder function, cooking end timer 1-600', minute minder, automatic preheating, keep warm
- safety devices: electronic child-safety lock, residual heat indicator, overflow alarm, safety switch-off
- minimum pan diameter: \varnothing 110 mm
- adjustable power levels: 1.4 - 1.5 - 1.6 - ... - 6.5 - 6.6 - 6.7 kW
- maximum absorbed power: 6.7 kW
- 79.5x38 cm cut out
flush-top: see website

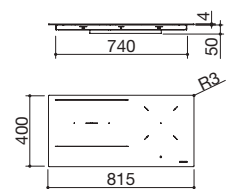

Induction zone power:

- 1 zone \varnothing 200 mm: 2.3-3 kW (*)
 - 2 Octa zones: 2.1-3 kW (*)
- (*) with Booster function

4 mm BLACK GLASS CERAMIC

code 1PIDC90N

CITY INDUCTION HOBS

flat glass edge built-in and flush

120 cm City built-in and flush hob
4 induction zones



FGB FT

Accessories: 74

- Touch controls
- functions: power management, Chef Cook, Bridge, automatic pan recognition, Booster, selective pan detection, pause/reminder function, cooking end timer 1-600', minute minder, automatic preheating, keep warm
- safety devices: electronic child-safety lock, residual heat indicator, overflow alarm, safety switch-off
- minimum pan diameter: \varnothing 110 mm
- adjustable power levels: 1.4 - 1.5 - 1.6 - ... - 7.2 - 7.3 - 7.4 kW
- maximum absorbed power: 7.4 kW
- 107.5x38 cm cut out
flush-top: see website

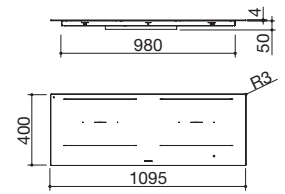

Induction zone power:

- 4 Octa zones: 2.1-3 kW (*)
- (*) with Booster function

4 mm BLACK GLASS CERAMIC

code 1PIDC120N

Accessories:

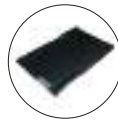

74

code 1BID

Standard equipment: integrated clips for quick attachment, seal.



GREEN PLUS INDUCTION HOBS

flat glass edge built-in and flush

60 cm Green Plus built-in and flush hob
4 induction zones



FGB FT NEW

- Touch controls
- functions: power management, Booster, selective pan detection, cooking end timer 1-99'
- safety devices: electronic child-safety lock, residual heat indicator, overflow alarm, safety switch-off
- adjustable power levels: 1-1.6-2.2-2.8-3.5-6-7.2 kW
- maximum absorbed power: 7.2 kW
- 56x49 cm cut out
flush-top: see website

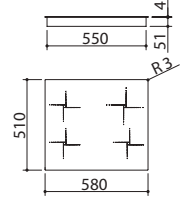

Induction zone power:

- 2 zones: ø 210 mm: 1.5-2 kW (*)
 - 2 zones: ø 145 mm: 1.2-1.6 kW (*)
- (*) with Booster function

4 mm BLACK GLASS CERAMIC

code 1PIDGP6N

4 mm WHITE GLASS CERAMIC

code 1PIDGP6B

Standard equipment: fixing clips, seal.



B_FREE INDUCTION HOBS square edge built-in

36 cm B_Free built-in hob

2 induction zones



70 cm B_Free built-in hob

4 induction zones



SQEB

- extra-thick AISI 304 stainless steel
- functions: power management, Booster, selective pan detection, automatic preheating, keep warm
- safety devices: electronic child-safety lock, residual heat indicator, safety switch-off
- minimum pan diameter: \varnothing 90 mm
- adjustable power levels: 1.6 - 2.0 - 2.4 - ... - 2.8 - 3.2 - 3.7 kW
- maximum absorbed power: 3.7 kW
- 34x49.5 cm cut out

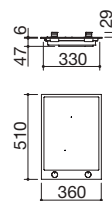

Induction zone power:

- 1 zone \varnothing 200 mm: 2.3-3 kW (*)
- 1 zone \varnothing 160 mm: 1.4-2.1 kW (*)

(*) with Booster function

BLACK GLASS CERAMIC/SATIN STAINLESS STEEL code 1PBF3ID

SQEB

Accessories: 74

- extra-thick AISI 304 stainless steel
- functions: power management, Bridge, Booster, selective pan detection, automatic preheating, keep warm
- safety devices: electronic child-safety lock, residual heat indicator, safety switch-off
- minimum pan diameter: \varnothing 110 mm
- adjustable power levels: 1.6 - 2.0 - 2.8 - 3.5 - 4.3 - 5 - 5.5 - 6 - 7.4 kW
- maximum absorbed power: 7.4 kW
- 66.5x49.5 cm cut out

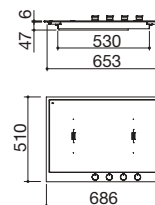

Induction zone power:

- 4 Octa zones: 2.1-3 kW (*)

(*) with Booster function

BLACK GLASS CERAMIC/SATIN STAINLESS STEEL code 1PBF7ID

Accessories:



74

code 1BID

Standard equipment: fixing clips, seal.



B_FREE
FUSION version

Visit the website
www.barazzasrl.it



LAB EVOLUTION COOKER HOOD

downdraft built-in and flush

90 cm Lab Evolution downdraft cooker hood built-in and flush

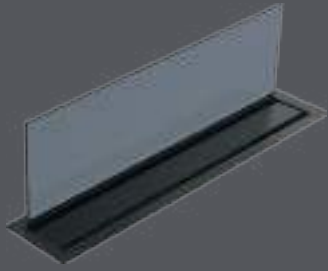

Remote control included



FEB FT NEW

Accessories: 41

- matt black AISI 304 stainless steel
- fixed deflector glass
- optional filter extraction
- speed: 3+1
- pressure: 334 Pa
- air flow: 800 m³/h
- noise level: 41 - 66 Lw (dBA)
- extractor outlet: Ø150 mm + rectangular pipe connector 220x90 mm
- stainless steel filters
- alarm function for filter cleaning
- remote control included
- energy rating C
- set up for remote control from Barazza scales
- compatible with induction hobs with zones in line
- compatible with Barazza gas hobs codes 1PLE2D and 1PLB2T
- maximum absorbed power: 0.275 kW
- 86x16 cm cut out
- flush-top: see website

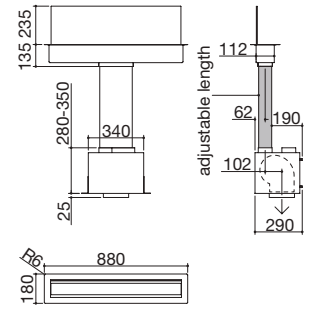

MATT BLACK STAINLESS STEEL/GREY GLASS code 1KLE9

Accessories:



41

code 1FC1



B_DRAFT COOKER HOODS downdraft built-in and flush

90 cm B_Draft downdraft cooker hood built-in and flush



120 cm B_Draft downdraft cooker hood built-in and flush



Remote control included



FEB FT

Accessories: 48

- AISI 304 stainless steel
- optional filter extraction
- speeds: 3 + intensive speed
- air flow: 1000 m³/h
- pressure: 500 Pa
- noise level: 49-70 Lw(dBA)
- extraction outlet Ø 150 mm + reducer Ø 120 mm
- lighting: 3000 K LED strip lighting
- Soft-Touch electronic controls
- stainless steel filters
- functions: filter maintenance warning
- remote control included
- energy rating C
- set up for remote control from Barazza scales
- compatible with gas and induction hobs
- maximum absorbed power: 0.3 kW
- 85.8x10 cm cut out flush-top: see website

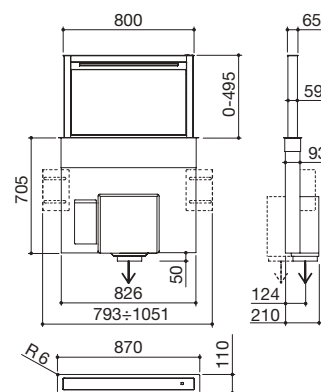

SATIN STAINLESS STEEL

code 1KBDD9

FEB FT

Accessories: 49

- AISI 304 stainless steel
- optional filter extraction
- speeds: 3 + intensive speed
- air flow: 1000 m³/h
- pressure: 500 Pa
- noise level: 49-70 Lw(dBA)
- extraction outlet Ø 150 mm + reducer Ø 120 mm
- lighting: 3000 K LED strip lighting
- Soft-Touch electronic controls
- stainless steel filters
- functions: filter maintenance warning
- remote control included
- energy rating C
- set up for remote control from Barazza scales
- compatible with gas and induction hobs
- maximum absorbed power: 0.3 kW
- 113.8x10 cm cut out flush-top: see website

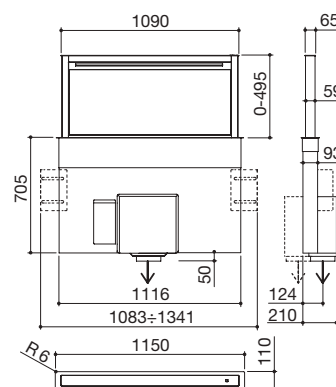

SATIN STAINLESS STEEL

code 1KBDD12

Accessories:



48

code 1FC3



49

code 1FC4

Height 50 cm

The B_Draft cooker hood, compatible with both gas and induction hobs, is 50 cm tall which ensures optimum extraction.

Remote motor

In all versions of the B_Draft cooker hood a remote motor can be installed upon request.

B_ AMBIENT COOKER HOODS ceiling

90 cm B_Ambient ceiling cooker hood



120 cm B_Ambient ceiling cooker hood

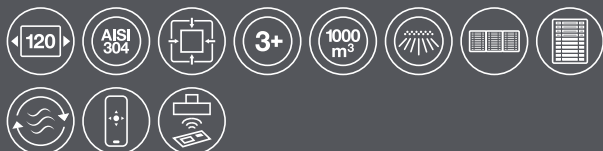

Remote control included



Accessories: 41

- AISI 304 stainless steel
- perimeter extraction
- optional filter extraction
- speeds: 3 + intensive speed
- air flow: 1000 m³/h
- pressure: 425 Pa
- noise level: 41-72 Lw(dBA)
- extraction outlet Ø 150 mm + reducer Ø 120 mm
- lighting: 3000 K LED strip lighting
- Soft-Touch electronic controls
- stainless steel filters
- functions: filter maintenance warning, air circulation
- remote control included
- energy rating B
- set up for remote control from Barazza scales
- maximum absorbed power: 0.3 kW
- 87x47.6 cm cut out

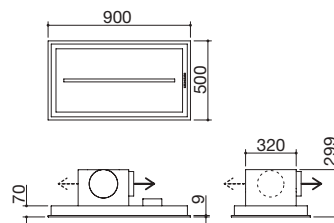

SATIN STAINLESS STEEL

code 1KBAS9

Accessories: 41

- AISI 304 stainless steel
- perimeter extraction
- optional filter extraction
- speeds: 3 + intensive speed
- air flow: 1000 m³/h
- pressure: 409 Pa
- noise level: 41-72 Lw(dBA)
- extraction outlet Ø 150 mm + reducer Ø 120 mm
- lighting: 3000 K LED strip lighting
- Soft-Touch electronic controls
- stainless steel filters
- functions: filter maintenance warning, air circulation
- remote control included
- energy rating B
- set up for remote control from Barazza scales
- maximum absorbed power: 0.3 kW
- 117x47.6 cm cut out

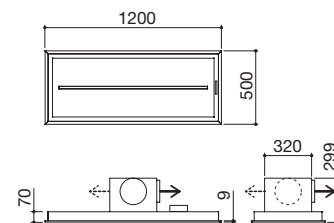

SATIN STAINLESS STEEL

code 1KBAS12

Accessories:



41

code 1FCA1

Remote motor

In all versions of the B_Ambient cooker hood a remote motor can be installed upon request.

Advice for installation

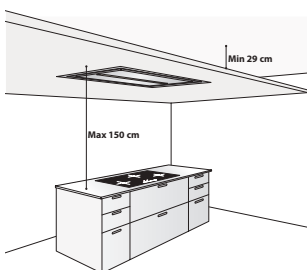

B_DRAFT



B_AMBIENT



COOKER HOODS

LAB EVOLUTION



CITY GLASS COOKER HOODS FOR INDUCTION HOBS wall

90 cm City Glass wall cooker hood



120 cm City Glass wall cooker hood



energy rating A

- 4 mm thick tempered glass
- speeds: 3 + intensive speed
- air flow: 800 m³/h
- pressure: 565 Pa
- noise level: 45-64 Lw(dBA)
- extraction outlet: Ø 150 mm + reducer Ø 120 mm
- lighting: 4000 K LED strip lighting
- electronic controls
- stainless steel filters
- telescopic hose: H 77.5 - 105.5 cm
- set up for remote control from Barazza scales
- maximum absorbed power: 0.3 kW

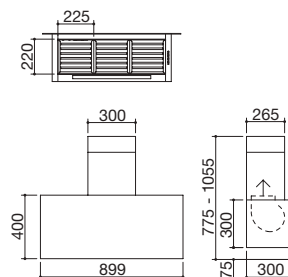

BLACK GLASS

code 1KCYP9

energy rating A

- 4 mm thick tempered glass
- speeds: 3 + intensive speed
- air-flow: 800 m³/h
- pressure: 565 Pa
- noise level: 45-64 Lw(dBA)
- extraction outlet: Ø 150 mm + reducer Ø 120 mm
- lighting: 4000 K LED strip lighting
- electronic controls
- stainless steel filters
- telescopic hose: H 77.5 - 105.5 cm
- set up for remote control from Barazza scales
- maximum absorbed power: 0.3 kW

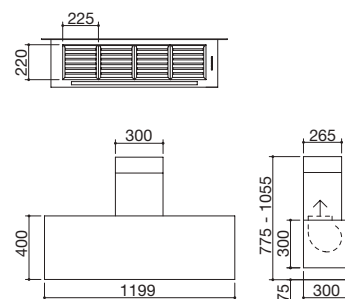

BLACK GLASS

code 1KCYP12

MOOD COOKER HOODS

wall

90 cm Mood wall cooker hood



120 cm Mood wall cooker hood



energy rating A

Accessories: 41

- 4 mm thick AISI 304 stainless steel
- optional filter extraction
- speeds: 3 + intensive speed
- air flow: 800 m³/h
- pressure: 501 Pa
- noise level: 39-65 Lw(dBA)
- extractor outlet: Ø 150 mm + reducer Ø 120 mm
- lighting: 4000 K LED strip lighting
- electronic controls
- filters: stainless steel
- telescopic hose H 74.5 ÷ 102.5
- set up for remote control from Barazza scales
- maximum absorbed power: 0.3 kW

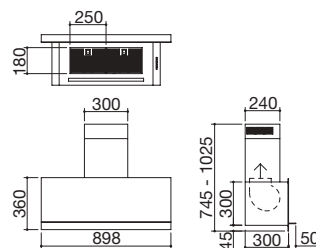

SATIN STAINLESS STEEL 4 mm/BLACK code 1KMDP9

energy rating A

Accessories: 41

- 4 mm thick AISI 304 stainless steel
- optional filter extraction
- speeds: 3 + intensive speed
- air flow: 800 m³/h
- pressure: 501 Pa
- noise level: 39-65 Lw(dBA)
- extractor outlet: Ø 150 mm + reducer Ø 120 mm
- lighting: 4000 K LED strip lighting
- electronic controls
- filters: stainless steel
- telescopic hose H 74.5 ÷ 102.5
- set up for remote control from Barazza scales
- maximum absorbed power: 0.3 kW

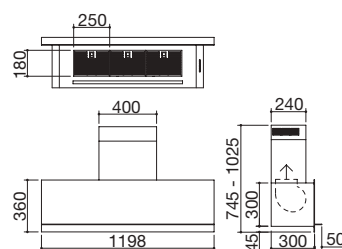

SATIN STAINLESS STEEL 4 mm/BLACK code 1KMDP12

Accessories:



41
code 1FC1



STEEL COOKER HOODS

wall

90 cm Steel wall cooker hood



120 cm Steel wall cooker hood



energy rating **A**

Accessories: **41**

- AISI 304 stainless steel
- optional filter extraction
- speeds: 3 + intensive speed
- air-flow: 800 m³/h
- pressure: 501 Pa
- noise level: 39-65 Lw(dBA)
- extraction outlet Ø 150 mm + reducer Ø 120 mm
- lighting: 4000 K LED strip lighting
- electronic controls
- stainless steel filters
- telescopic hose: H 77.5 - 105.5 cm
- set up for remote control from Barazza scales
- maximum absorbed power: 0.3 kW

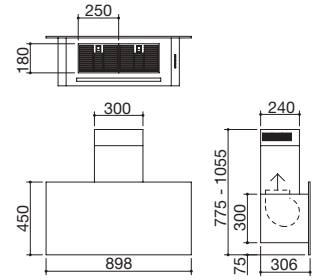

SATIN/BLACK STAINLESS STEEL

code **1KSTP9**

energy rating **A**

Accessories: **41**

- AISI 304 stainless steel
- optional filter extraction
- speeds: 3 + intensive speed
- air-flow: 800 m³/h
- pressure: 501 Pa
- noise level: 39-65 Lw(dBA)
- extraction outlet Ø 150 mm + reducer Ø 120 mm
- lighting: 4000 K LED strip lighting
- electronic controls
- stainless steel filters
- telescopic hose: H 77.5 - 105.5 cm
- set up for remote control from Barazza scales
- maximum absorbed power: 0.3 kW

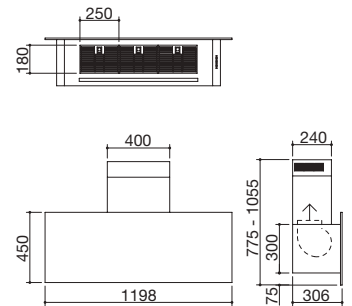

SATIN/BLACK STAINLESS STEEL

code **1KSTP12**

Accessories:



41

code **1FC1**

UNIQUE COOKER HOODS

wall

90 cm Unique wall cooker hood

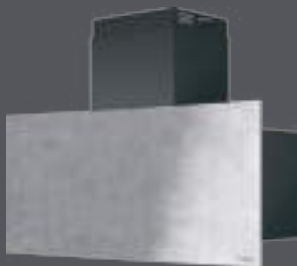

120 cm Unique wall cooker hood

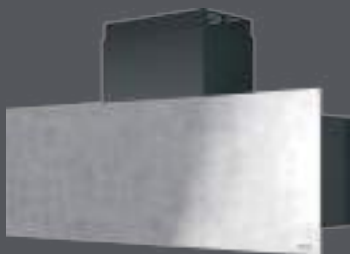

energy rating A

Accessories: 41

- AISI 304 stainless steel
- optional filter extraction
- speeds: 3 + intensive speed
- air flow: 800 m³/h
- pressure: 501 Pa
- noise level: 39-65 Lw(dBA)
- extraction outlet Ø 150 mm + reducer Ø 120 mm
- lighting: 4000 K LED strip lighting
- electronic controls
- stainless steel filters
- telescopic hose: H 77.5 - 105.5 cm
- set up for remote control from Barazza scales
- maximum absorbed power: 0.3 kW

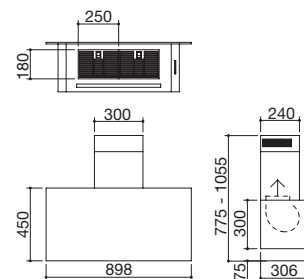

VINTAGE/BLACK STAINLESS STEEL

code 1KUNP91

energy rating A

Accessories: 41

- AISI 304 stainless steel
- optional filter extraction
- speeds: 3 + intensive speed
- air-flow: 800 m³/h
- pressure: 501 Pa
- noise level: 39-65 Lw(dBA)
- extraction outlet Ø 150 mm + reducer Ø 120 mm
- lighting: 4000 K LED strip lighting
- electronic controls
- stainless steel filters
- telescopic hose: H 77.5 - 105.5 cm
- set up for remote control from Barazza scales
- maximum absorbed power: 0.3 kW

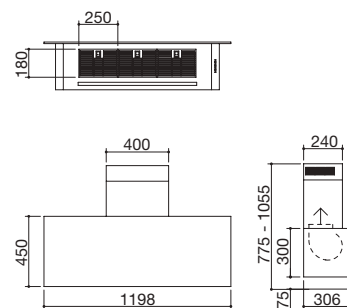

VINTAGE/BLACK STAINLESS STEEL

code 1KUNP121

Accessories:



41

code 1FC1



AURA ADVANCE



AURA ADVANCE REFRIGERATOR 60 cm built-in

60 cm Aura Advance combi-refrigerator
built-in



energy rating **D**

- Advanced No Frost
- Autodefrosting
- independent cooling systems
- Metal Cooling rear
- dark stainless steel finish details
- humidity control technology
- Holiday and Demo modes
- Tropical 43 °C
- Dual Control display with touch controls

Fridge equipment

- 3 tempered glass shelves
- 4 door shelves (1 adjustable V-Lift)
- 2 LED side lights, 1 LED top light
- ZeroDegree drawer
- drawer with VitaMod technology
- Super Cool function

Freezer equipment

- 1 removable Fast Freeze tray
- 2 drawers
- Drink Cool function

Accessories

- egg tray
- ice cube tray

Technical data

- sliding hinge
- reversible door
- Schuko mains plug
- total volume: 233 litres
- refrigerator volume: 170 litres
- refrigerator volume: 63 litres
- dimensions: 177x54x54.5 cm
- power supply: 220 – 240 V 50 Hz
- maximum absorbed power: 0.157 kW

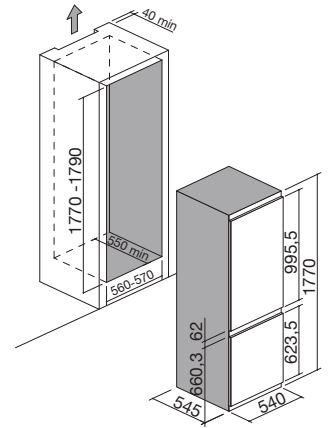

WHITE/DARK FINISH STAINLESS STEEL code **1FCA6I**



AURA ONE REFRIGERATOR 60 cm built-in

60 cm Aura One combi-refrigerator
built-in



energy rating E

- Advanced No Frost
- Autodefrosting
- independent cooling systems
- humidity control technology
- stainless steel finish details
- Holiday and Demo modes
- Tropical 43 °C
- Dual Control display with touch controls

Fridge equipment

- 4 tempered glass shelves
- 4 door shelves
- 2 LED side lights, 1 LED top light
- fruit and veg drawer with humidity control system
- Super Cool function

Freezer equipment

- 1 removable Fast Freeze tray
- 2 drawers
- Drink Cool function

Accessories

- egg tray
- ice cube tray

Technical data

- sliding hinge
- reversible door
- Schuko mains plug
- total volume: 233 litres
- refrigerator volume: 170 litres
- refrigerator volume: 63 litres
- dimensions: 177x54x54.5 cm
- power supply: 220 – 240 V 50 Hz
- maximum absorbed power: 0.157 kW

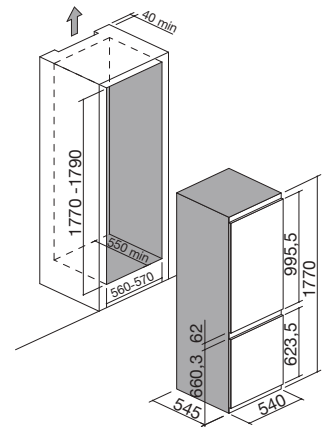

WHITE/STAINLESS STEEL

code 1FCE6I



AURA ADVANCE DISHWASHER 60 cm built-in

60 cm Aura Advance fully integrated dishwasher built-in



energy rating **D**

- 15 place settings
- 9 programs: Mini 14', Quick 30', Eco, Super 50', Dual Pro Wash 60 °C, Hygiene 70 °C, Smart 30-50 °C, Smart 50-60 °C, Smart 60-70 °C
- delayed start
- half load program
- Inverter motor
- Touch controls
- control panel in stainless steel finish

Configurations

- Triple Wash & Direct Wash
- AquaZone
- AcquaStop
- Extra Silent
- Extra Fast function
- energy-saving function
- Turbo dry
- AutoDoor (automatic opening)
- door InfoLED

Equipment

- internal side light
- metal filter
- 3 dark grey baskets (fixed lower baskets with 4 foldable racks, upper basket with 2 foldable racks, 4 cup shelves and 3 adjustable heights, adjustable third cutlery drawer)

Accessories

- cutlery basket

Technical data

- sliding door: plinth 2 cm min.
- door weight: 3-8 kg
- Schuko mains plug
- noise level: 39 dBA
- water consumption / Eco program: 9 litres
- dimensions: 59.8x55.5x82/87 h cm
- power supply: 220-240 V 50 Hz
- maximum absorbed power: 1.9 kW

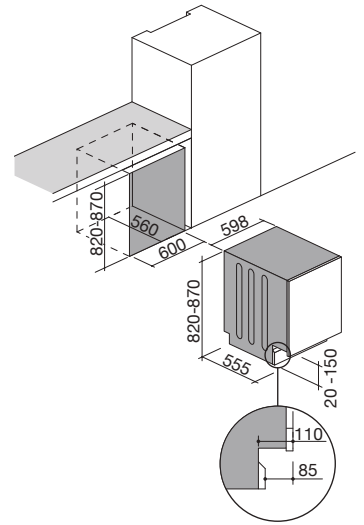

DARK GREY/STAINLESS STEEL

code **1LVA6I**

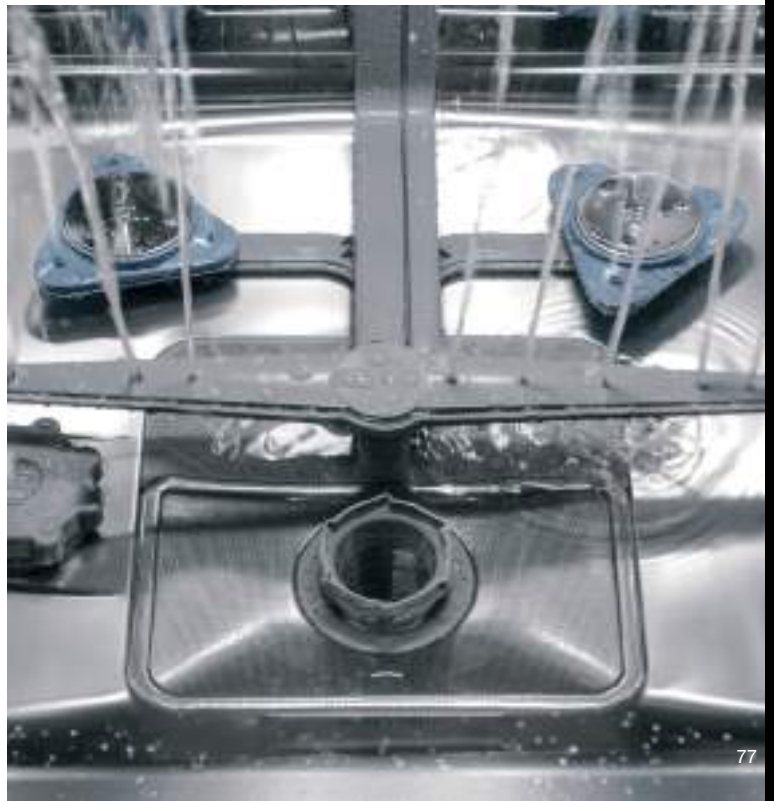

AURA ONE DISHWASHER 60 cm built-in

60 cm Aura One fully integrated dishwasher built-in



energy rating **D**

- 15 place settings
- 9 programs: Mini 14', Quick 30', Eco, Super 50', Dual Pro Wash 60 °C, Hygiene 70 °C, Smart 30-50 °C, Smart 50-60 °C, Smart 60-70 °C
- delayed start
- half load program
- Inverter motor
- Touch controls
- control panel in stainless steel finish

Configurations

- AquaZone
- AcquaStop
- Extra Silent
- Extra Fast function
- energy-saving function
- Turbo dry
- AutoDoor (automatic opening)
- door InfoLED

Equipment

- metal filter
- 3 dark grey baskets (fixed lower baskets with 4 foldable racks, upper basket with 2 foldable racks, 4 cup shelves and 2 adjustable heights, fixed third cutlery drawer)

Accessories

- cutlery basket

Technical data

- sliding door: plinth 6 cm min.
- door weight: 3-8 kg
- mains Schuko plug
- noise level: 44 dBA
- water consumption / Eco program: 9 litres
- dimensions: 59.8x55.5x82/87 h cm
- power supply: 220-240 V 50 Hz
- maximum absorbed power: 1.9 kW

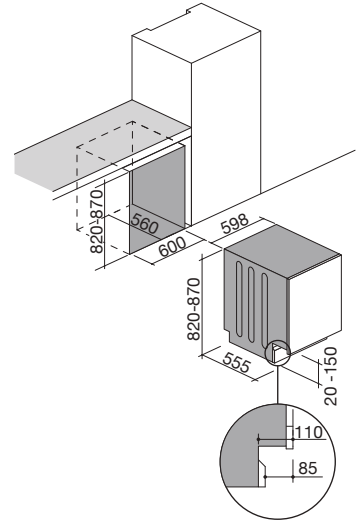

DARK GREY/STAINLESS STEEL

code **11VE61**



AURA ADVANCE



FLEXI SINKS

flat edge built-in and flush

86x56 cm Flexi built-in and flush sink
1 bowl with lowering



86x56 cm Flexi Kit built-in and flush sink
1 bowl with lowering + accessories kit and tap

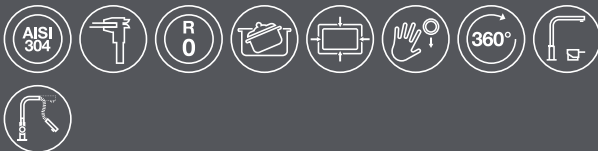

FEB FT Accessories: 8 17 20 25 40 43 61 62 66

- extra-thick AISI 304 stainless steel
- bowl with radius "0"
- 83x41.4x20.7 h bowl
- bowl with lowering for sliding of accessories
- equipment: 3½" basket strainer waste, Smart pop-up plug, stainless steel drain cover, perimeter overflow
- tap hole: 3 holes as standard
- base unit for bowls: 90
- 84x54 cm cut out
- flush-top: see website

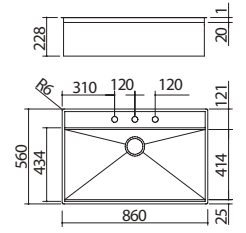

SATIN STAINLESS STEEL

code **1LFX91**

FEB FT Accessories: 8 17 20 25 40 62 66

- extra-thick AISI 304 stainless steel
- bowl with radius "0"
- 83x41.4x20.7 h bowl
- bowl with lowering for sliding of accessories
- equipment: 3½" black basket strainer waste, black Smart pop-up plug, black perimeter overflow, black HPL chopping board 1TOF26N, stainless steel perforated bowl cover with black HPL draining rack 1CIFX, Soul mixer tap with remote control and pull-out spray head 1RUBSORN
- tap hole: 3 holes as standard
- base unit for bowls: 90
- 84x54 cm cut out
- flush-top: see website

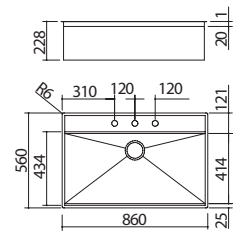

SATIN STAINLESS STEEL

code **1LFX91NK**



FLEXI SINKS

flat edge built-in and flush

105x56 cm Flexi built-in and flush sink
1 bowl with lowering



105x56 cm Flexi Kit built-in and flush sink
1 bowl with lowering + accessories kit and tap



FEB FT Accessories: 8 17 20 25 40 43 61 62 66

- extra-thick AISI 304 stainless steel
- bowl with radius "0"
- 102x41.4x20.7 h bowl
- bowl with lowering for sliding of accessories
- equipment: 3½" basket strainer waste, Smart pop-up plug, stainless steel drain cover, perimeter overflow
- tap hole: 3 holes as standard
- base unit for bowls: 120
- 103x54 cm cut out flush-top: see website

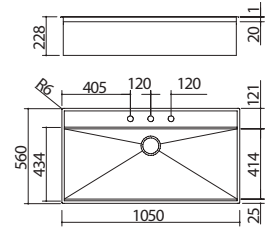

SATIN STAINLESS STEEL

code **1LFX101**

FEB FT Accessories: 8 17 20 25 40 61 66

- extra-thick AISI 304 stainless steel
- bowl with radius "0"
- 102x41.4x20.7 h bowl
- bowl with lowering for sliding of accessories
- equipment: 3½" black basket strainer waste, black Smart pop-up plug, black perimeter overflow, black HPL chopping board 1TOF26N, stainless steel colander with black HPL draining rack 1VSFX, Soul mixer tap with remote control and pull-out spray head 1RUBSORN
- tap hole: 3 holes as standard
- base unit for bowls: 120
- 103x54 cm cut out flush-top: see website

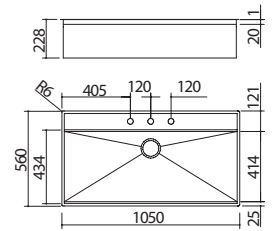

SATIN STAINLESS STEEL

code **1LFX101NK**

Standard equipment: fixing clips, seal, space-saver trap with dishwasher connection, cardboard packaging.
The mixer tap is not included for sinks codes 1LFX91, 1LFX101.



MOOD SINKS

4 mm built-in edge

86x51 cm Mood built-in sink

1 bowl + supporting surface with grooves



86x51 cm Mood built-in sink

2 bowls



86x51 cm Mood built-in sink

1 bowl



EB4

Accessories: 45 46 47 71

- 4 mm thick AISI 304 stainless steel
- bowl with radius "12"
- 40x40x20 h bowl
- equipment: 3 1/2" basket strainer waste, Smart pop-up plug, stainless steel drain cover, perimeter overflow
- tap hole: 2 holes as standard
- base unit for bowls: 50
- 84x49 cm cut out

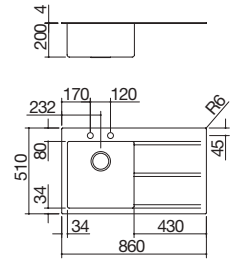

SATIN STAINLESS STEEL 4 mm supporting surface RH code 1LMDR91D

SATIN STAINLESS STEEL 4 mm supporting surface LH code 1LMDR91S

EB4 Accessories: 8 17 20 25 40 43 45 46 47 61 62 66 71

- 4 mm thick AISI 304 stainless steel
- bowls with radius "12"
- 34x40x20 h bowls
- equipment: 3 1/2" basket strainer waste, Smart pop-up plug, stainless steel drain cover, perimeter overflow
- tap hole: 2 holes as standard
- base unit for bowls: 90
- 84x49 cm cut out

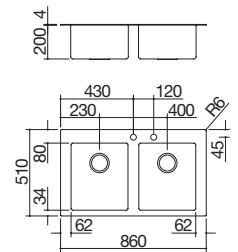

SATIN STAINLESS STEEL 4 mm

code 1LMDR92

EB4 Accessories: 8 17 20 25 40 43 45 46 47 61 62 66 71

- 4 mm thick AISI 304 stainless steel
- bowl with radius "12"
- 70x40x20 h bowl
- equipment: 3 1/2" basket strainer waste, Smart pop-up plug, stainless steel drain cover, perimeter overflow
- tap hole: 2 holes as standard
- base unit for bowls: 90
- 84x49 cm cut out

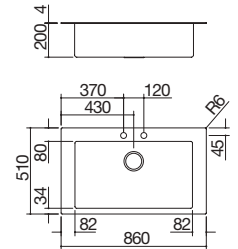

SATIN STAINLESS STEEL 4 mm

code 1LMDR91

Standard equipment: fixing clips, seal, space-saver trap with dishwasher connection, cardboard packaging.
The mixer tap is not included.



MIZU SINK

built-in edge 40 mm

52x52 cm Mizu sink
1 bowl with lowering



MKB

Accessories: **70**

- perimeter frame h 40 mm in 4 mm thick stainless steel
- extra-thick AISI 304 stainless steel
- bowls radius "0" with lowering
- 49x42x17.2 h bowl
- equipment: 3½" basket strainer waste, Smart pop-up plug, stainless steel drain cover, perimeter overflow
- tap hole: 3 holes as standard
- base unit for bowls: 60
- 51x51 cm cut out

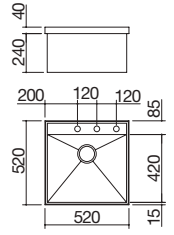

SATIN STAINLESS STEEL

code 1LMZ51



MIZU SINK

built-in edge 40 mm

100x52 cm Mizu sink

1 bowl with lowering + drainer



130x52 cm Mizu sink

1 bowl with lowering + drainer



Accessories: 68 69

- perimeter frame h 40 mm in 4 mm thick stainless steel
- extra-thick AISI 304 stainless steel
- bowls radius "0" with lowering for sliding accessories
- 42x49x17.2 h bowl
- equipment: 3½" basket strainer waste, Smart pop-up plug, stainless steel drain cover, perimeter overflow
- tap hole: 3 holes as standard
- base unit for bowls: 60
- 99x51 cm cut out
- the sink is reversible

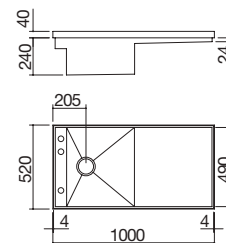

SATIN STAINLESS STEEL

code 1LMZ105



Accessories: 69 70

- perimeter frame h 40 mm in 4 mm thick stainless steel
- extra-thick AISI 304 stainless steel
- bowls radius "0" with lowering for sliding accessories
- 57x49x17.2 h bowl
- equipment: 3½" basket strainer waste, Smart pop-up plug, stainless steel drain cover, perimeter overflow
- tap hole: 3 holes as standard
- base unit for bowls: 80
- 129x51 cm cut out
- the sink is reversible

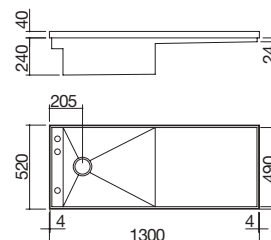

SATIN STAINLESS STEEL

code 1LMZ135

Standard equipment: fixing clips, space-saver trap with dishwasher connection, cardboard packaging. The mixer tap is not included.

Mizu stainless steel sliding chopping board



68 for Mizu sinks code 1LMZ105
- chopping board dimensions: 50.6x50.6 cm cod. 1TMZ1

69 for Mizu sinks code 1LMZ135
- chopping board dimensions: 65.6x50.6 cm cod. 1TMZ2

70 Kit for Total and Plan cladding
(Teflon runners, rubber seals, primer) cod. 1KRLMZ

Technical data sheets for carrying out any cladding are available on website: www.barazzasrl.it

EASY SINKS

flat-edge built-in and flush

86x51 cm Easy built-in and flush sink
1 bowl + drainer



86x51 cm Easy built-in and flush sink
2 bowls



86x51 cm Easy built-in and flush sink
1 bowl



FEB FT Accessories: 8 17 20 25 40 43 61 62 66 71

- extra-thick AISI 304 stainless steel
- bowl with radius "15"
- 40x40x21.5 h bowl
- equipment: 3½" basket strainer waste, stainless steel drain cover, perimeter overflow
- tap hole: 1 hole as standard, 2nd and 3rd hole upon request
- base unit for bowls: 60
- 84x49 cm cut out flush-top: see website

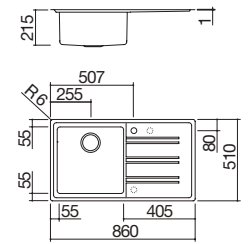

SATIN STAINLESS STEEL drainer RH code **1LES91PD**

SATIN STAINLESS STEEL drainer LH code **1LES91PS**

FEB FT Accessories: 8 17 20 25 40 43 61 62 66

- extra-thick AISI 304 stainless steel
- bowl with radius "15"
- 34x40x21.5 h bowl
- equipment: 3½" basket strainer waste, stainless steel drain cover, perimeter overflow
- tap hole: 1 hole as standard, 2nd hole upon request
- base unit for bowls: 90
- 84x49 cm cut out flush-top: see website

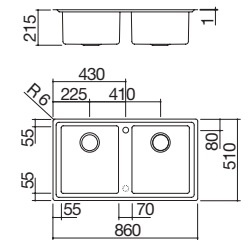

SATIN STAINLESS STEEL code **1LES92P**

FEB FT Accessories: 8 17 20 25 40 43 61 62 66 71

- extra-thick AISI 304 stainless steel
- bowl with radius "15"
- 71x40x21.5 h bowl
- equipment: 3½" basket strainer waste, stainless steel drain cover, perimeter overflow
- tap hole: 1 hole as standard, 2nd hole upon request
- base unit for bowls: 90
- 84x49 cm cut out flush-top: see website

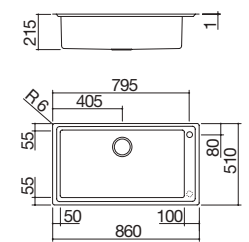

SATIN STAINLESS STEEL code **1LES91P**

Standard equipment: fixing clips, space-saver trap with dishwasher connection, cardboard packaging. The mixer tap is not included.

EASY SINKS

lowered edge built-in

86x50 cm Easy built-in sink

1 bowl + drainer



86x50 cm Easy built-in sink

2 bowls



86x50 cm Easy built-in sink

1 bowl



Accessories: 8 17 20 25 40 43 61 62 66 71

- extra-thick AISI 304 stainless steel
- bowl with radius "15"
- 40x40x21.5 h bowl
- equipment: 3½" basket strainer waste, stainless steel drain cover, perimeter overflow
- tap hole: 1 hole as standard, 2nd and 3rd hole upon request
- base unit for bowls: 60
- 84x48 cm cut out

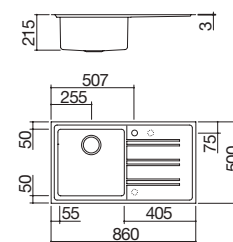

SATIN STAINLESS STEEL drainer RH

code 1LES91RD

SATIN STAINLESS STEEL drainer LH

code 1LES91RS



Accessories: 8 17 20 25 40 43 61 62 66

- extra-thick AISI 304 stainless steel
- bowl with radius "15"
- 34x40x21.5 h bowl
- equipment: 3½" basket strainer waste, stainless steel drain cover, perimeter overflow
- tap hole: 1 hole as standard, 2nd hole upon request
- base unit for bowls: 90
- 84x48 cm cut out

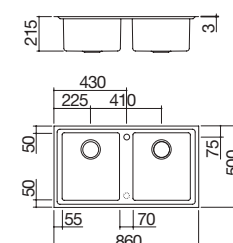

SATIN STAINLESS STEEL

code 1LES92R



Accessories: 8 17 20 25 40 43 61 62 66 71

- extra-thick AISI 304 stainless steel
- bowl with radius "15"
- 71x40x21.5 h bowl
- equipment: 3½" basket strainer waste, stainless steel drain cover, perimeter overflow
- tap hole: 1 hole as standard, 2nd hole upon request
- base unit for bowls: 60
- 84x48 cm cut out

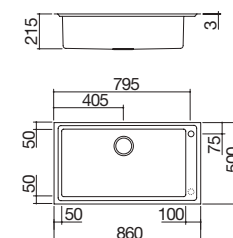

SATIN STAINLESS STEEL

code 1LES91R

EASY SINKS

lowered edge built-in

86x50 cm Easy Kit built-in sink

1 bowl + accessories kit and tap



Accessories: 8 17 25 40 61 62 66 71

- extra-thick AISI 304 stainless steel
- bowl with radius "15"
- 71x40x21.5 h bowl
- equipment: 3/2" basket strainer waste, stainless steel drain cover, perimeter overflow, black HPL chopping board 1TOF26N, stainless steel colander with draining rack 1VSOF, Steel Doccia mixer tap 1RUBMSTD
- tap hole: 1 hole as standard, 2nd hole upon request
- base unit for bowls: 90
- 84x48 cm cut out

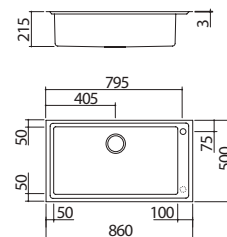

SATIN STAINLESS STEEL

code 1LES91RK

116x50 cm Easy built-in sink

1 bowl + drainer



Accessories: 8 17 20 25 40 43 61 62 66 71

- extra-thick AISI 304 stainless steel
- bowl with radius "15"
- 71x40x21.5 h bowl
- equipment: 3/2" basket strainer waste, stainless steel drain cover, perimeter overflow
- tap hole: 1 hole as standard, 2nd hole upon request
- base unit for bowls: 90
- 114x48 cm cut out

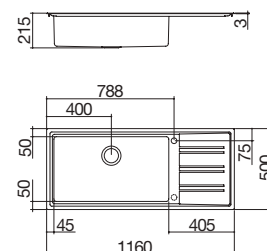

SATIN STAINLESS STEEL drainer RH

code 1LES121RD

SATIN STAINLESS STEEL drainer LH

code 1LES121RS

116x50 cm Easy built-in sink

2 bowl + drainer



Accessories: 8 17 20 25 40 43 61 62 66

- extra-thick AISI 304 stainless steel
- bowl with radius "15"
- 34x40x21.5 h bowl
- equipment: 3/2" basket strainer waste, stainless steel drain cover, perimeter overflow
- tap hole: 1 hole as standard, 2nd and 3rd hole upon request
- base unit for bowls: 90
- 114x48 cm cut out

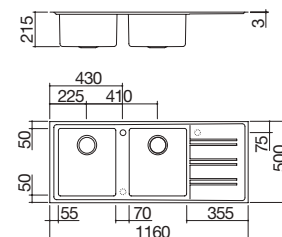

SATIN STAINLESS STEEL drainer RH

code 1LES12RD

SATIN STAINLESS STEEL drainer LH

code 1LES12RS

Standard equipment: fixing clips, seal, space-saver trap with dishwasher connection, cardboard packaging. The mixer tap is not included for sinks codes 1LES91RD, 1LES91RS, 1LES92R, 1LES91R, 1LES121RD, 1LES121RS, 1LES12RD, 1LES12RS.

B SMART SINKS

flat edge built-in and flush

39x50.5 cm B_Smart built-in and flush sink
1 bowl



55x50.5 cm B_Smart built-in and flush sink
1 bowl



67x50.5 cm B_Smart built-in and flush sink
1 bowl



76x50.5 cm B_Smart built-in and flush sink
1 bowl



FEB FT

Accessories: 8 17 20 25 38 40
43 45 61 62 66

- extra-thick AISI 304 stainless steel
- bowl with radius "15"
- 34x40x19.5 h bowl
- equipment: 3½" basket strainer waste, perimeter overflow
- tap hole
- base unit for bowls: 45
- 37x49 cm cut out
flush-top: see website

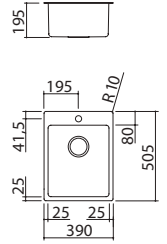

SATIN STAINLESS STEEL

code 1LBS41

FEB FT

Accessories: 8 17 20 25 38 40
43 45 61 62 66 71

- extra-thick AISI 304 stainless steel
- bowl with radius "15"
- 50x40x19.5 h bowl
- equipment: 3½" basket strainer waste, perimeter overflow
- tap hole
- base unit for bowls: 60
- 53x49 cm cut out
flush-top: see website

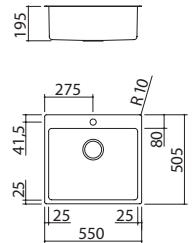

SATIN STAINLESS STEEL

code 1LBS61

FEB FT NEW

Accessories: 8 17 20 25 38 40
43 45 61 62 66 71

- extra-thick AISI 304 stainless steel
- bowl with radius "15"
- 62x40x19.5 h bowl
- equipment: 3½" basket strainer waste, perimeter overflow
- tap hole
- base unit for bowls: 75
- 65x49 cm cut out
flush-top: see website

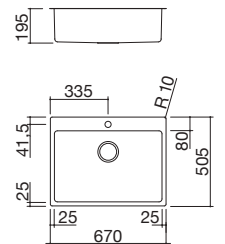

SATIN STAINLESS STEEL

code 1LBS71

FEB FT

Accessories: 8 17 20 25 38 40
43 45 61 62 66 71

- extra-thick AISI 304 stainless steel
- bowl with radius "15"
- 71x40x19.5 h bowl
- equipment: 3½" basket strainer waste, perimeter overflow
- tap hole
- base unit for bowls: 80
- 74x49 cm cut out
flush-top: see website

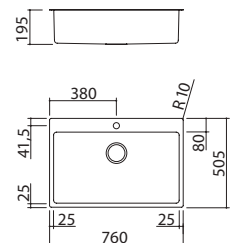

SATIN STAINLESS STEEL

code 1LBS81

Standard equipment: fixing clips, seal, space-saver trap with dishwasher connection, cardboard packaging.
The mixer tap is not included.

B_OPEN SINKS lowered edge built-in

58x51 cm B_Open built-in sink

1 bowl



79x51 cm B_Open built-in sink

2 bowls



79x51 cm B_Open built-in sink

1 bowl



LEB Accessories: 8 17 20 25 40 43 45 61 62 66 71

- extra-thick AISI 304 stainless steel
- bowl with radius "15"
- 50x40x19.5 h bowl
- equipment: 3½" basket strainer waste pop-up plug, stainless steel drain cover, perimeter overflow
- tap hole: 2 holes as standard
- base unit for bowls: 60
- 56x49 cm cut out

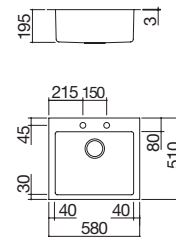

SATIN STAINLESS STEEL

code 1LBO61

LEB Accessories: 8 17 20 25 40 43 45 61 62 66

- extra-thick AISI 304 stainless steel
- bowl with radius "15"
- 34x40x19.5 h bowl
- equipment: 3½" basket strainer waste pop-up plug, stainless steel drain cover, perimeter overflow
- tap hole: 2 holes as standard
- base unit for bowls: 80
- 77x49 cm cut out

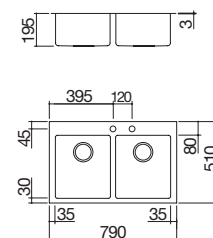

SATIN STAINLESS STEEL

code 1LBO82

LEB Accessories: 8 17 20 25 40 43 45 61 62 66 71

- extra-thick AISI 304 stainless steel
- bowl with radius "15"
- 71x40x19.5 h bowl
- equipment: 3½" basket strainer waste pop-up plug, stainless steel drain cover, perimeter overflow
- tap hole: 2 holes as standard
- base unit for bowls: 80
- 77x49 cm cut out

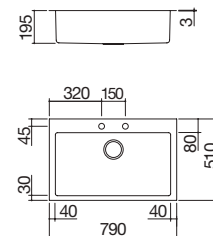

SATIN STAINLESS STEEL

code 1LBO81

Standard equipment: fixing clips, seal, space-saver trap with dishwasher connection, cardboard packaging.
The mixer tap is not included.

UNIQUE SINKS

lowered edge built-in

58x51 cm Unique built-in sink

1 bowl



79x51 cm Unique built-in sink

2 bowls



79x51 cm Unique built-in sink

1 bowl



LEB Accessories: 8 17 20 25 40 43 45 61 62 66 71

- extra-thick AISI 304 stainless steel
- bowl with radius "15"
- 50x40x19.5 h bowl
- equipment: 3½" basket strainer waste, pop-up plug, stainless steel drain cover, perimeter overflow
- tap hole: 2 holes as standard
- base unit for bowls: 60
- 56x49 cm cut out

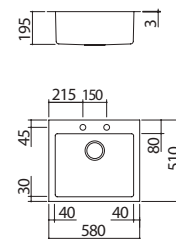

VINTAGE STAINLESS STEEL

code 1LUN61

LEB Accessories: 8 17 20 25 40 43 45 61 62 66

- extra-thick AISI 304 stainless steel
- bowl with radius "15"
- 34x40x19.5 h bowl
- equipment: 3½" basket strainer waste, pop-up plug, stainless steel drain cover, perimeter overflow
- tap hole: 2 holes as standard
- base unit for bowls: 80
- 77x49 cm cut out

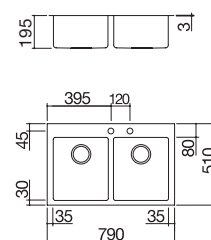

VINTAGE STAINLESS STEEL

code 1LUN82

LEB Accessories: 8 17 20 25 40 43 45 61 62 66 71

- extra-thick AISI 304 stainless steel
- bowl with radius "15"
- 71x40x19.5 h bowl
- equipment: 3½" basket strainer waste, pop-up plug, stainless steel drain cover, perimeter overflow
- tap hole: 2 holes as standard
- base unit for bowls: 80
- 77x49 cm cut out

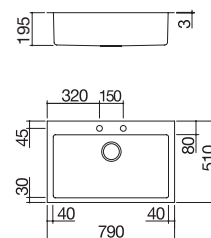

VINTAGE STAINLESS STEEL

code 1LUN81

Standard equipment: fixing clips, seal, space-saver trap with dishwasher connection, cardboard packaging.
The mixer tap is not included.



EASY



B_SMART



B_OPEN



UNIQUE

LAB SINKS WITH LOWERING flat edge built-in, flush and undermounted

57x51 cm Lab built-in, flush and undermounted sink
1 bowl with lowering



86x51 cm Lab built-in, flush and undermounted sink
1 bowl with lowering



86x51 cm Lab Kit built-in, flush and undermounted sink
1 bowl with lowering + accessories kit and tap



FEB FT UM

Accessories: 6 19 71

- extra-thick AISI 304 stainless steel
- bowl with radius "0"
- 54x38.8x18.3 h bowl
- bowl with lowering for sliding of accessories
- equipment: 3½" basket strainer waste, Smart pop-up plug, stainless steel drain cover, perimeter overflow
- tap hole: 2 holes as standard
- base unit for bowls:
 - built-in and flush: 60
 - undermounted: 80
- 56x49 cm cut out
flush-top and undermounted: see website

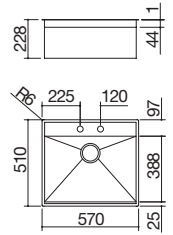

SATIN STAINLESS STEEL

code 1LLB61

FEB FT UM

Accessories: 6 19 67 71

- extra-thick AISI 304 stainless steel
- bowl with radius "0"
- 83x38.8x18.3 h bowl
- bowl with lowering for sliding of accessories
- equipment: 3½" basket strainer waste, Smart pop-up plug, stainless steel drain cover, perimeter overflow
- tap hole: 2 holes as standard
- base unit for bowls:
 - built-in and flush: 90
 - undermounted: 100
- 85x49 cm cut out
flush-top and undermounted: see website

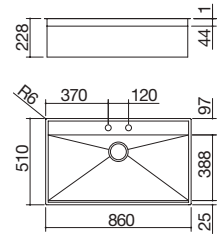

SATIN STAINLESS STEEL

code 1LLB91

FEB FT UM

Accessories: 67 71

- extra-thick AISI 304 stainless steel
- bowl with radius "0"
- 83x38.8x18.3 h bowl
- bowl with lowering for sliding of accessories
- equipment: 3½" basket strainer waste, stainless steel drain cover, perimeter overflow, stainless steel and black HPL multipurpose chopping board 1TBF, stainless steel colander 1VBF, B_Free telescopic mixer tap with remote control 1RUBMBFA
- tap hole: 2 holes as standard
- base unit for bowls:
 - built-in and flush: 90
 - undermounted: 100
- 85x49 cm cut out
flush-top and undermounted: see website

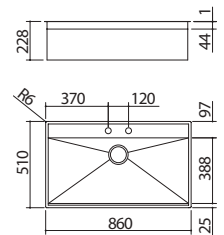

SATIN STAINLESS STEEL

code 1LLB91K

Standard equipment: fixing clips, space-saver trap with dishwasher connection, cardboard packaging. The mixer tap is not included for sinks codes 1LLB61, 1LLB91.

LAB COVER SINKS

flat-edge built-in and flush

57x51 cm Lab Cover built-in and flush sink
1 bowl with cover + tap



86x51 cm Lab Cover built-in and flush sink
1 bowl with cover + tap



FEB FT

Accessories: 38 71

- extra-thick AISI 304 stainless steel
- bowl with radius "0"
- 54x34x18.3 h bowl
- balanced, removable, stainless steel cover with manual opening
- equipment: 3½" basket strainer waste, perimeter overflow, B_Free telescopic mixer tap with remote control 1RUBMBFA
- tap hole: 2 holes as standard
- base unit for bowls: 60
- 56x49 cm cut out flush-top: see website

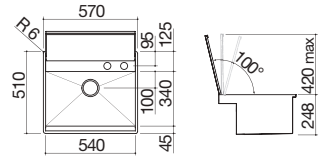

SATIN STAINLESS STEEL

code 1LLB60

FEB FT

Accessories: 38 71

- extra-thick AISI 304 stainless steel
- bowl with radius "0"
- 83x34x18.3 h bowl
- balanced, removable, stainless steel cover with manual opening
- equipment: 3½" basket strainer waste, perimeter overflow, B_Free telescopic mixer tap with remote control 1RUBMBFA
- tap hole: 2 holes as standard
- base unit for bowls: 90
- 85x49 cm cut out flush-top: see website

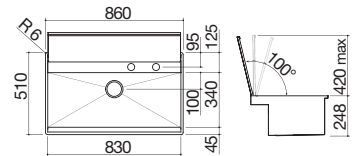

SATIN STAINLESS STEEL

code 1LLB90

Standard equipment: fixing clips, space-saver trap with dishwasher connection, cardboard packaging.

B_FREE SINKS

square edge built-in

86x51 cm B_Free built-in sink

1 bowl with lowering



86x51 cm B_Free Kit built-in sink

1 bowl with lowering + accessories kit and tap



Multi-purpose chopping board

The range of accessories enhances the functionality of B_Free sinks. These include the innovative multipurpose stainless steel and black HPL chopping board that also serves as a bowl cover and drainer.



SQEB

Accessories: 6 19 71

- extra-thick AISI 304 stainless steel
- bowl with radius "0" vertical wall edges
- bowl with radius "12" bottom edges
- 83x39x19 h bowl
- bowl with lowering for sliding of accessories
- equipment: 3½" basket strainer waste, stainless steel drain cover, pop-up plug, perimeter overflow
- tap hole: 2 holes as standard
- base unit for bowls: 90
- 84x49 cm cut out

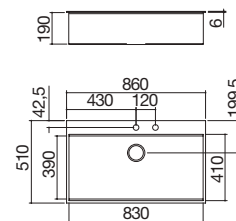

SATIN STAINLESS STEEL

code 1LBF9

SQEB

Accessories: 71

- extra-thick AISI 304 stainless steel
- bowl with radius "0" vertical wall edges
- bowl with radius "12" bottom edges
- 83x39x19 h bowl
- bowl with lowering for sliding of accessories
- equipment: 3½" basket strainer waste, stainless steel drain cover, perimeter overflow, stainless steel and black HPL multi-purpose chopping board 1TBF, stainless steel colander 1VBF, B_Free Kit mixer tap with pull-out spray head 1RUBMBFRK
- tap hole: 3 holes as standard
- base unit for bowls: 90
- 84x49 cm cut out

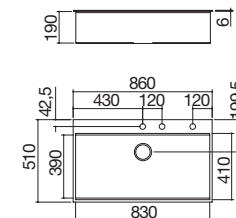

SATIN STAINLESS STEEL

code 1LBF9K

Standard equipment: fixing clips, seal, space-saver trap with dishwasher connection, cardboard packaging. The mixer tap is not included for sink code 1LBF9.

LAB



B_FREE



LAB COVER



STAINLESS STEEL SINKS AND SQUARE BOWLS

B_FAST SINKS

lowered edge built-in

79x50 cm B_Fast built-in sink

1 bowl + drainer



79x50 cm B_Fast built-in sink

2 bowls



86x50 cm B_Fast built-in sink

1 bowl + drainer



86x50 cm B_Fast built-in sink

2 bowls



LEB

Accessories: 5 12 14 24 38

- AISI 304 stainless steel
- 34x39x21 h bowl
- equipment: 3½" basket strainer waste, perimeter overflow
- tap hole: 1 hole as standard, 2nd hole upon request
- base unit for bowls: 45
- 77x48 cm cut out

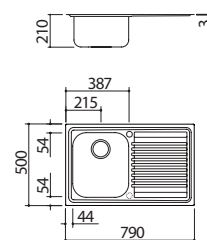

SATIN STAINLESS STEEL drainer RH code 1LFS81D

SATIN STAINLESS STEEL drainer LH code 1LFS81S

LEB

Accessories: 5 12 14 24 38

- AISI 304 stainless steel
- 34x39x21 h bowl
- equipment: 3½" basket strainer waste, perimeter overflow
- tap hole: 1 hole as standard, 2nd hole upon request
- base unit for bowls: 80
- 77x48 cm cut out

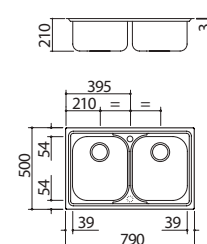

SATIN STAINLESS STEEL

code 1LFS82

LEB

Accessories: 5 12 14 24 38

- AISI 304 stainless steel
- 34x39x21 h bowl
- equipment: 3½" basket strainer waste, perimeter overflow
- tap hole: 1 hole as standard, 2nd hole upon request
- base unit for bowls: 45
- 84x48 cm cut out

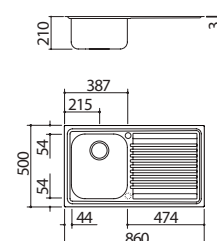

SATIN STAINLESS STEEL drainer RH code 1LFS91D

SATIN STAINLESS STEEL drainer LH code 1LFS91S

LEB

Accessories: 5 12 14 24 38

- AISI 304 stainless steel
- 34x39x21 h bowl
- equipment: 3½" basket strainer waste, perimeter overflow
- tap hole: 1 hole as standard, 2nd hole upon request
- base unit for bowls: 90
- 84x48 cm cut out

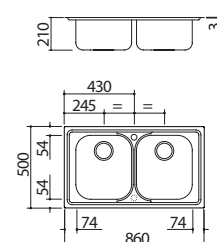

SATIN STAINLESS STEEL

code 1LFS92

B_FAST SINKS lowered edge built-in

100x50 cm B_Fast built-in sink

1 bowl + drainer



116x50 cm B_Fast built-in sink

2 bowls + drainer



B_FAST SINKS lowered edge built-in

83x83 cm B_Fast built-in sink

2 corner bowls + drainer

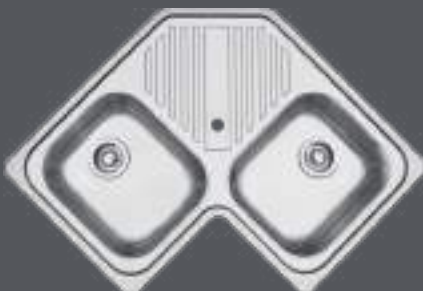

LEB

Accessories: 38

- AISI 304 stainless steel
- 50x40x21 h bowl
- equipment: 3½" basket strainer waste, perimeter overflow
- tap hole: 1 hole as standard, 2nd hole upon request
- base unit for bowls: 60
- 98x48 cm cut out

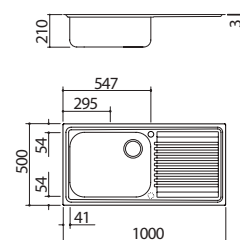

SATIN STAINLESS STEEL drainer RH

code 1LFS10D

SATIN STAINLESS STEEL drainer LH

code 1LFS10S

LEB

Accessories: 5 12 14 24 38

- AISI 304 stainless steel
- 34x39x21 h bowl
- equipment: 3½" basket strainer waste, perimeter overflow
- tap hole: 1 hole as standard, 2nd hole upon request
- base unit for bowls: 80
- 114x48 cm cut out

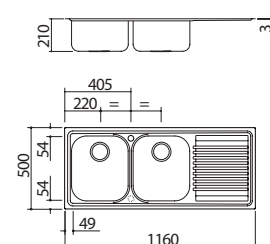

SATIN STAINLESS STEEL drainer RH

code 1LFS12D

SATIN STAINLESS STEEL drainer LH

code 1LFS12S

SEB

Accessories: 5 12 14 24 38

- AISI 304 stainless steel
- 34x39x21 h bowls
- equipment: 3½" basket strainer waste, perimeter overflow
- tap hole: 1 hole as standard
- base unit for bowls: 90x90
- cut out: see website

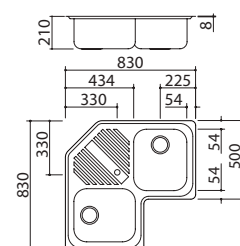

SATIN STAINLESS STEEL

code 1LFS82A

Standard equipment: fixing clips, seal, space-saver trap with dishwasher connection, cardboard packaging. The mixer tap is not included.

B_Level SINKS lowered edge built-in

86x50 cm B_Level built-in sink

1 bowl + drainer



86x50 cm B_Level built-in sink

2 bowls



100x50 cm B_Level built-in sink

1½ bowl + drainer



116x50 cm B_Level built-in sink

2 bowls + drainer



LEB

Accessories: 5 12 14 24

- extra-thick AISI 304 stainless steel
- 34x39x21 h bowl
- equipment: 3½" basket strainer waste, pop-up plug, perimeter overflow
- tap hole: 2 holes as standard
- base unit for bowls: 45
- 84x48 cm cut out

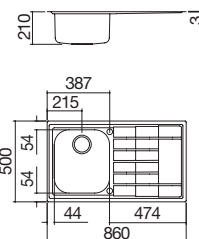

SATIN STAINLESS STEEL drainer RH

code 1LLV90/1D

SATIN STAINLESS STEEL drainer LH

code 1LLV90/1S

LEB

Accessories: 5 12 14 24

- extra-thick AISI 304 stainless steel
- 34x39x21 h bowl
- equipment: 3½" basket strainer waste, pop-up plug, perimeter overflow
- tap hole: 2 holes as standard
- base unit for bowls: 90
- 84x48 cm cut out

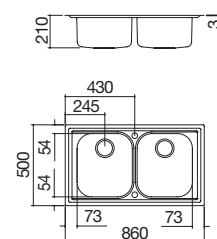

SATIN STAINLESS STEEL

code 1LLV90/2

LEB

Accessories: 5 12 13 14 24

- extra-thick AISI 304 stainless steel
- 34x39x21 h and 15x30x16.5 h bowls
- equipment: 3½" basket strainer waste, pop-up plug, perimeter overflow
- tap hole: 2 holes as standard
- base unit for bowls: 60
- 98x48 cm cut out

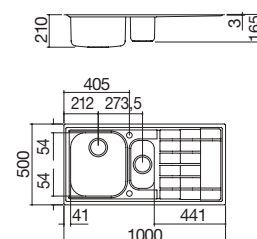

SATIN STAINLESS STEEL drainer RH

code 1LLV100/D

SATIN STAINLESS STEEL drainer LH

code 1LLV100/S

LEB

Accessories: 5 12 14 24

- extra-thick AISI 304 stainless steel
- 34x39x21 h bowl
- equipment: 3½" basket strainer waste, pop-up plug, perimeter overflow
- tap hole: 2 holes as standard
- base unit for bowls: 80
- 114x48 cm cut out

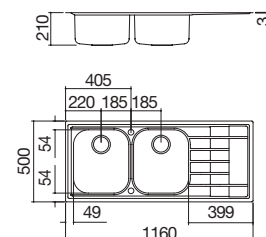

SATIN STAINLESS STEEL drainer RH

code 1LLV120/2D

SATIN STAINLESS STEEL drainer LH

code 1LLV120/2S

Standard equipment: fixing clips, seal, space-saver trap with dishwasher connection, cardboard packaging. The mixer tap is not included.



SELECT SINKS lowered edge built-in

58.5x50 cm Select built-in sink
1 bowl



58,5x50 cm Select built-in sink
1½ bowl



LEB

Accessories: **38**

- extra-thick AISI 304 stainless steel
- 50x40x20 h bowl
- equipment: 3½" basket strainer waste, perimeter overflow
- tap hole: 1 hole as standard
- base unit for bowls: 60
- 56x48 cm cut out

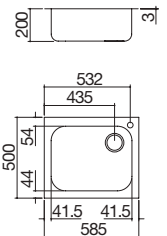

SATIN STAINLESS STEEL

code 1IS6060/1

LEB

Accessories: **5 12 13 14 24 38**

- extra-thick AISI 304 stainless steel
- 34x39x19.5 h and 15x30x15 h bowls
- equipment: 3½" basket strainer waste, perimeter overflow
- tap hole: 1 hole as standard, 2nd hole upon request
- base unit for bowls: 60
- 56x48 cm cut out

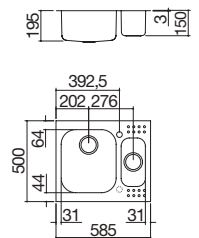

SATIN STAINLESS STEEL

code 1IS6060

SELECT SINKS

lowered edge built-in

86x50 cm Select built-in sink

1 bowl + supporting surface



86x50 cm Select built-in sink

2 bowls



116x50 cm Select built-in sink

2 bowls + supporting surface



LEB

Accessories: 38

- extra-thick AISI 304 stainless steel
- 40x40x20 h bowl
- equipment: 3½" basket strainer waste, overflow hole
- tap hole: 1 hole as standard
- base unit for bowls: 60
- 84x48 cm cut out

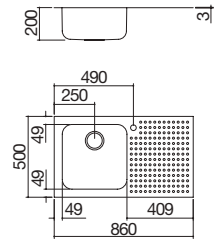

SATIN STAINLESS STEEL supporting surface RH code 11S9060/1D

SATIN STAINLESS STEEL supporting surface LH code 11S9060/1S

LEB

Accessories: 2 23 38

- extra-thick AISI 304 stainless steel
- 40x40x20 h and 33x33x20 h bowls
- equipment: 3½" basket strainer waste, overflow hole
- tap hole: 1 hole as standard
- base unit for bowls: 60
- 84x48 cm cut out

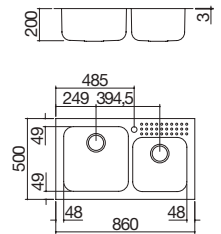

SATIN STAINLESS STEEL

code 11S9060/2

LEB

Accessories: 2 23 38

- extra-thick AISI 304 stainless steel
- 40x40x20 h and 33x33x20 h bowls
- equipment: 3½" basket strainer waste, overflow hole
- tap hole: 1 hole as standard
- base unit for bowls: 90
- 114x48 cm cut out

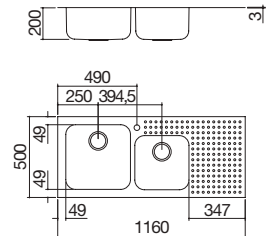

SATIN STAINLESS STEEL supporting surface RH code 11S12060/2D

SATIN STAINLESS STEEL supporting surface LH code 11S12060/2S

Standard equipment: fixing clips, seal, space-saver trap with dishwasher connection, cardboard packaging. The mixer tap is not included.



B_FAST



B_LEVEL

STAINLESS STEEL SINKS AND SQUARE BOWLS



SELECT

FLEXI SQUARE BOWLS R. "0" flat edge built-in and flush

80x46 cm Flexi Square bowl R. "0"
built-in and flush, 1 bowl with lowering



FEB FT

Accessories: 18 21 44 63 64 65 67

- extra-thick AISI 304 stainless steel
- 80x46x21.5 h bowl
- bowl with lowering for sliding of accessories
- equipment: 3½" basket strainer waste, stainless steel drain cover, perimeter overflow
- base unit for bowls: 90
- 81x49 cm cut out
- flush-top: see website

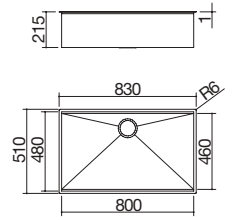

SATIN STAINLESS STEEL

code 1QA8411

Standard equipment: fixing clips, seal, space-saver trap with dishwasher connection, cardboard packaging. The mixer tap is not included.



SQUARE BOWLS R. "15"

flat edge built-in, flush and undermounted

18x40 cm Square Bowl R. "15"
built-in, flush and undermounted



34x40 cm Square Bowl R. "15"
built-in, flush and undermounted



40x40 cm Square Bowl R. "15"
built-in, flush and undermounted



45x40 cm Square Bowl R. "15"
built-in, flush and undermounted



FEB FT UM

Accessories: 17 38 54 64 65

- extra-thick AISI 304 stainless steel
- 18x40x14 h bowl
- equipment: 3½" basket strainer waste, perimeter overflow
- base unit for bowls:
 - built-in and flush: 30
 - undermounted: 40
- 20x42 cm cut out + notch for overflow
- flush-top and undermounted: see website

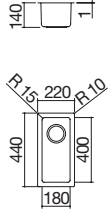

SATIN STAINLESS STEEL built-in and flush code 1X1840I

SATIN STAINLESS STEEL undermounted code 1X1840S

FEB FT UM

Accessories: 8 17 20 25 38 40 43 45

54 61 62 64 65 66

- extra-thick AISI 304 stainless steel
- 34x40x19.5 h bowl
- equipment: 3½" basket strainer waste, perimeter overflow
- base unit for bowls:
 - built-in and flush: 45
 - undermounted: 50
- 36x42 cm cut out + notch for overflow
- flush-top and undermounted: see website

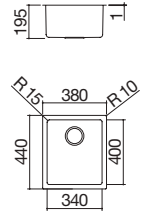

SATIN STAINLESS STEEL built-in and flush code 1X3440I

SATIN STAINLESS STEEL undermounted code 1X3440S

FEB FT UM

Accessories: 8 17 20 25 38 40 43 45

54 61 62 64 65 66 71

- extra-thick AISI 304 stainless steel
- 40x40x19.5 h bowl
- equipment: 3½" basket strainer waste, perimeter overflow
- base unit for bowls:
 - built-in and flush: 50
 - undermounted: 60
- 42x42 cm cut out + notch for overflow
- flush-top and undermounted: see website

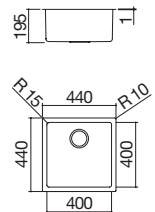

SATIN STAINLESS STEEL built-in and flush code 1X4040I

SATIN STAINLESS STEEL undermounted code 1X4040S

FEB FT UM

Accessories: 8 17 20 25 38 40 43 45

54 61 62 64 65 66 71

- extra-thick AISI 304 stainless steel
- 45x40x19.5 h bowl
- equipment: 3½" basket strainer waste, perimeter overflow
- base unit for bowls:
 - built-in and flush: 60
 - undermounted: 60
- 47x42 cm cut out + notch for overflow
- flush-top and undermounted: see website

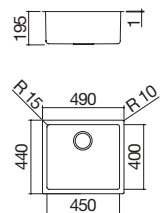

SATIN STAINLESS STEEL built-in and flush code 1X4540I

SATIN STAINLESS STEEL undermounted code 1X4540S

SQUARE BOWLS R. "15"

flat edge built-in, flush and undermounted

50x40 cm Square Bowl R. "15"
built-in, flush and undermounted



58.5x44 cm Double Square Bowl R. "15"
built-in, flush and undermounted



62x40 cm Square Bowl R. "15"
built-in, flush and undermounted



71x40 cm Square Bowl R. "15"
built-in, flush and undermounted



FEB FT UM Accessories: 8 17 20 25 38 40 43 45
54 61 62 64 65 66 71

- extra-thick AISI 304 stainless steel
- 50x40x19.5 h bowl
- equipment: 3½" basket strainer waste, perimeter overflow
- base unit for bowls:
 - built-in and flush: 60
 - undermounted: 75
- 52x42 cm cut out + notch for overflow
- flush-top and undermounted: see website

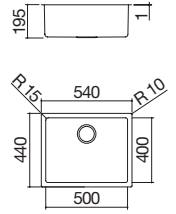

SATIN STAINLESS STEEL built-in and flush code 1X5040I

SATIN STAINLESS STEEL undermounted code 1X5040S

FEB FT UM Accessories: 8 17 20 25 38 40 43 45
54 61 62 64 65 66

- extra-thick AISI 304 stainless steel
- 34x40x19.5 h and 18x40x14 h bowls
- equipment: 3½" basket strainer waste, perimeter overflow
- base unit for bowls:
 - built-in and flush: 60
 - undermounted: 75
- 56.5x42 cm cut out + notch for overflow
- flush-top and undermounted: see website

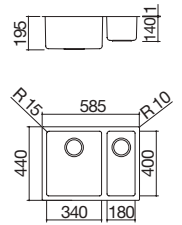

SATIN STAINLESS STEEL built-in and flush code 1X642I

SATIN STAINLESS STEEL undermounted code 1X642S

FEB FT UM Accessories: 8 17 20 25 38 40 43 45
54 61 62 64 65 66 71

- extra-thick AISI 304 stainless steel
- 62x40x19.5 h bowl
- equipment: 3½" basket strainer waste, perimeter overflow
- base unit for bowls: 75 cm
- 64x42 cm cut out + notch for overflow
- flush-top and undermounted: see website

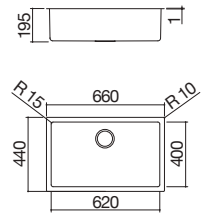

SATIN STAINLESS STEEL built-in and flush code 1X6240I

SATIN STAINLESS STEEL undermounted code 1X6240S

FEB FT UM Accessories: 8 17 20 25 38 40 43 45
54 61 62 64 65 66 71

- extra-thick AISI 304 stainless steel
- 71x40x19.5 h bowl
- equipment: 3½" basket strainer waste, perimeter overflow
- base unit for bowls:
 - built-in and flush: 80
 - undermounted: 90
- 73x42 cm cut out + notch for overflow
- flush-top and undermounted: see website

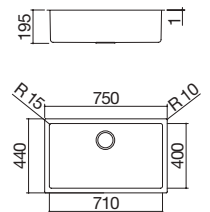

SATIN STAINLESS STEEL built-in and flush code 1X7040I

SATIN STAINLESS STEEL undermounted code 1X7040S

SQUARE BOWLS R. "15" flat edge built-in, flush and undermounted

75x44 cm Double Square Bowl R. "15"
built-in, flush and undermounted



FEB
FT
UM
 Accessories: 8 17 20 25 38 40 43 45
54 61 62 64 65 66

- extra-thick AISI 304 stainless steel
- 34x40x19.5 h bowls
- equipment: 3½" basket strainer waste, perimeter overflow
- base unit for bowls:
 - built-in and flush: 80
 - undermounted: 90
- 73x42 cm cut out + notch for overflow
- flush-top and undermounted: see website

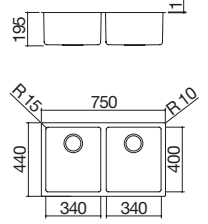

SATIN STAINLESS STEEL built-in and flush code 1X842I

SATIN STAINLESS STEEL undermounted code 1X842S

Standard equipment: fixing clips, seal, space-saver trap with dishwasher connection, cardboard packaging. The mixer tap is not included.



VINTAGE SQUARE BOWLS R. "15" flat edge built-in, flush and undermounted

50x40 cm Vintage Square Bowl R. "15"
built-in, flush and undermounted



71x40 cm Vintage Square Bowl R. "15"
built-in, flush and undermounted



FEB
FT
UM
 Accessories: 8
17
20
25
38
40
43
45
54
61
62
64
65
66
71

- extra-thick AISI 304 stainless steel
- 50x40x19.5 h bowl
- equipment: 3½" basket strainer waste, perimeter overflow
- base unit for bowls:
 - built-in and flush: 60
 - undermounted: 75
- 52x42 cm cut out + notch for overflow
- flush-top and undermounted: see website

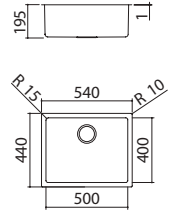

VINTAGE STAINLESS STEEL

code 1X50V

FEB
FT
UM
 Accessories: 8
17
20
25
38
40
43
45
54
61
62
64
65
66
71

- extra-thick AISI 304 stainless steel
- 71x40x19.5 h bowl
- equipment: 3½" basket strainer waste, perimeter overflow
- base unit for bowls:
 - built-in and flush: 80
 - undermounted: 90
- 73x42 cm cut out + notch for overflow
- flush-top and undermounted: see website

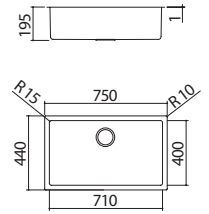

VINTAGE STAINLESS STEEL

code 1X70V

Standard equipment: fixing clips, seal, space-saver trap with dishwasher connection, cardboard packaging. The mixer tap is not included.



SQUARE BOWLS R. "12"

flat edge built-in, flush and undermounted

34x40 cm Square Bowl R. "12"

built-in, flush and undermounted



40x40 cm Square Bowl R. "12"

built-in, flush and undermounted



50x40 cm Square Bowl R. "12"

built-in, flush and undermounted



70x40 cm Square Bowl R. "12"

built-in, flush and undermounted



FEB **FT** **UM** Accessories: 8 17 20 25 40 43 45 54
61 62 64 65 66 71

- extra-thick AISI 304 stainless steel
- 34x40x20 h bowl
- equipment: 3½" basket strainer waste, stainless steel drain cover, perimeter overflow
- base unit for bowls:
 - built-in and flush: 45
 - undermounted: 50
- 37.5x43.7 cm cut out
- flush-top and undermounted: see website

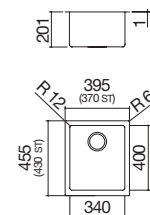

SATIN STAINLESS STEEL built-in and flush code 1QR34I

SATIN STAINLESS STEEL undermounted code 1QR34S

FEB **FT** **UM** Accessories: 8 17 20 25 40 43 45 54
61 62 64 65 66 71

- extra-thick AISI 304 stainless steel
- 40x40x20 h bowl
- equipment: 3½" basket strainer waste, stainless steel drain cover, perimeter overflow
- base unit for bowls:
 - built-in and flush: 50
 - undermounted: 60
- 43.5x43.7 cm cut out
- flush-top and undermounted: see website

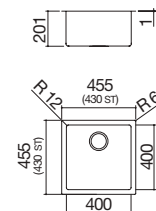

SATIN STAINLESS STEEL built-in and flush code 1QR40I

SATIN STAINLESS STEEL undermounted code 1QR40S

FEB **FT** **UM** Accessories: 8 17 20 25 40 43 45 54
61 62 64 65 66 71

- extra-thick AISI 304 stainless steel
- 50x40x20 h bowl
- equipment: 3½" basket strainer waste, stainless steel drain cover, perimeter overflow
- base unit for bowls:
 - built-in and flush: 60
 - undermounted: 75
- 53.5x43.7 cm cut out
- flush-top and undermounted: see website

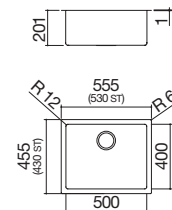

SATIN STAINLESS STEEL built-in and flush code 1QR50I

SATIN STAINLESS STEEL undermounted code 1QR50S

FEB **FT** **UM** Accessories: 8 17 20 25 40 43 45 54
61 62 64 65 66 71

- extra-thick AISI 304 stainless steel
- 70x40x20 h bowl
- equipment: 3½" basket strainer waste, stainless steel drain cover, perimeter overflow
- base unit for bowls:
 - built-in and flush: 80
 - undermounted: 90
- 73.5x43.7 cm cut out
- flush-top and undermounted: see website

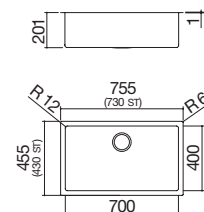

SATIN STAINLESS STEEL built-in and flush code 1QR70I

SATIN STAINLESS STEEL undermounted code 1QR70S

Standard equipment: fixing clips, seal, space-saver trap with dishwasher connection, cardboard packaging. The mixer tap is not included.

SQUARE BOWLS R. "0"

flat edge built-in, flush and undermounted

34x40 cm Square Bowl R. "0"
built-in, flush and undermounted



40x40 cm Square Bowl R. "0"
built-in, flush and undermounted



50x40 cm Square Bowl R. "0"
built-in, flush and undermounted



70x40 cm Square Bowl R. "0"
built-in, flush and undermounted



FEB FT UM Accessories: 8 17 20 25 38 40 43 45
54 61 62 64 65 66 71

- extra-thick AISI 304 stainless steel
- 34x40x21.5 h bowl
- equipment: 3½" basket strainer waste, perimeter overflow
- base unit for bowls:
 - built-in and flush: 45
 - undermounted: 50
- 37.5x43.7 cm cut out
- flush-top and undermounted: see website

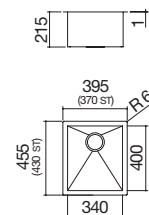

SATIN STAINLESS STEEL built-in and flush code 1Q3440I

SATIN STAINLESS STEEL undermounted code 1Q3440S

FEB FT UM Accessories: 8 17 20 25 38 40 43 45
54 61 62 64 65 66 71

- extra-thick AISI 304 stainless steel
- 40x40x21.5 h bowl
- equipment: 3½" basket strainer waste, perimeter overflow
- base unit for bowls:
 - built-in and flush: 50
 - undermounted: 60
- 43.5x43.7 cm cut out
- flush-top and undermounted: see website

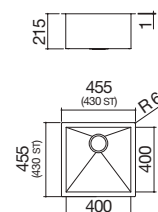

SATIN STAINLESS STEEL built-in and flush code 1Q4040I

SATIN STAINLESS STEEL undermounted code 1Q4040S

FEB FT UM Accessories: 8 17 20 25 38 40 43 45
54 61 62 64 65 66 71

- extra-thick AISI 304 stainless steel
- 50x40x21.5 h bowl
- equipment: 3½" basket strainer waste, perimeter overflow
- base unit for bowls:
 - built-in and flush: 60
 - undermounted: 75
- 53.5x43.7 cm cut out
- flush-top and undermounted: see website

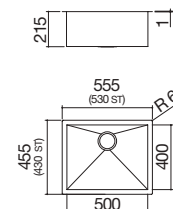

SATIN STAINLESS STEEL built-in and flush code 1Q5040I

SATIN STAINLESS STEEL undermounted code 1Q5040S

FEB FT UM Accessories: 8 17 20 25 38 40 43 45
54 61 62 64 65 66 71

- extra-thick AISI 304 stainless steel
- 70x40x21.5 h bowl
- equipment: 3½" basket strainer waste, perimeter overflow
- base unit for bowls:
 - built-in and flush: 80
 - undermounted: 90
- 73.5x43.7 cm cut out
- flush-top and undermounted: see website

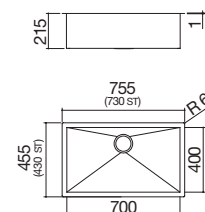

SATIN STAINLESS STEEL built-in and flush code 1Q7040I

SATIN STAINLESS STEEL undermounted code 1Q7040S

Standard equipment: fixing clips, seal, space-saver trap with dishwasher connection, cardboard packaging. The mixer tap is not included.



R."15"



R."12"



R."0"

CITY SINKS

high edge built-in B_Granite

86x51 cm City built-in sink

1 bowl



86x51 cm City Kit built-in sink

1 bowl + Accessories kit and tap



HEBS

Accessories: 71

- 79.6x36.5x20 h bowl
- equipment: 3½" basket strainer waste, stainless steel drain cover, perimeter overflow
- tap hole: designed for 5 holes
- base unit for bowls: 90
- 84x48 cm cut out

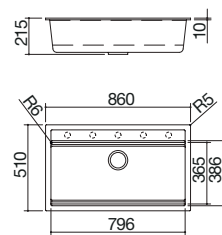

BLACK B_GRANITE

code **1LCY91N**

WHITE B_GRANITE

code **1LCY91B**

HEBS

- 79.6x36.5x20 h bowl
- equipment: 3½" basket strainer waste, stainless steel drain cover, perimeter overflow, 2 HPL support grids for bowl bottom 1GQRN, Soul mixer tap with remote control and pull-out spray head 1RUBSORN
- tap hole: designed for 5 holes
- base unit for bowls: 90
- 84x48 cm cut out

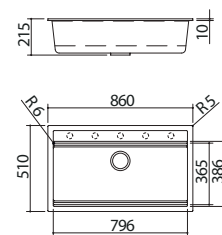

BLACK B_GRANITE

code **1LCY91NK**

Standard equipment: fixing clips, seal, space-saver trap with dishwasher connection, cardboard packaging. The mixer tap is not included for sinks codes 1LCY91N and 1LCY91B.



SOUL SINKS

high edge built-in B_Granite

57x50 cm Soul built-in sink
1 bowl



79.5x50.5 cm Soul built-in sink
1 bowl



HEBS

- 50x40x20 h bowl
- equipment: 3½" basket strainer waste, stainless steel drain cover, perimeter overflow
- tap hole: designed for 3 holes
- base unit for bowls: 60
- 55x48 cm cut out

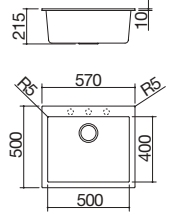

BLACK B_GRANITE

code **1LSO61N**

WHITE B_GRANITE

code **1LSO61B**

HEBS

Accessories: **8 20 25 40 43 45 61 62**

- 72x40x20 h bowl
- equipment: 3½" basket strainer waste, stainless steel drain cover, perimeter overflow
- tap hole: designed for 3 holes
- base unit for bowls: 80
- 77x48 cm cut out

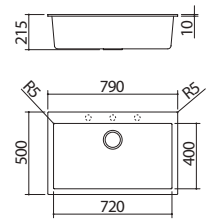

BLACK B_GRANITE

code **1LSO81N**

WHITE B_GRANITE

code **1LSO81B**



SOUL SINKS

high edge built-in B_Granite

79.5x50 cm Soul built-in sink
2 bowls



HEBS

Accessories: 8 25 40 43 61

- 34.5x39.5x21 h bowl
- equipment: 3½" basket strainer waste, stainless steel drain cover, perimeter overflow
- tap hole: designed for 5 holes
- base unit for bowls: 80
- 77x48 cm cut out

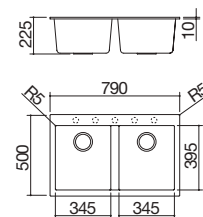

BLACK B_GRANITE

code 1LSO82N

WHITE B_GRANITE

code 1LSO82B

Standard equipment: fixing clips, space-saver trap with dishwasher connection, cardboard packaging. The mixer tap is not included.



SOUL SQUARE BOWLS

undermounted

B_Granite

50x40 cm Soul Square Bowl
undermounted



72x39.5 cm Soul Double Square Bowl
undermounted



UM

Accessories: 8 20 25 40 43 45 61 62

- 50x40x20 h bowl
- equipment: 3½" basket strainer waste, stainless steel drain cover, perimeter overflow
- base unit for bowls: 60
- undermounted: see website

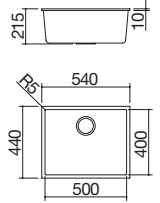

BLACK B_GRANITE

code 1QSO61NS

GREY B_GRANITE

code 1QSO61GS

WHITE B_GRANITE

code 1QSO61BS

UM

Accessories: 8 25 40 43 61

- 34.5x39.5x21 h bowl
- equipment: 3½" basket strainer waste, stainless steel drain cover, perimeter overflow
- base unit for bowls: 80
- undermounted: see website

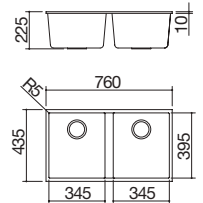

BLACK B_GRANITE

code 1QSO82NS

WHITE B_GRANITE

code 1QSO82BS

SOUL SQUARE BOWLS

undermounted

B_Granite

72.5x40 cm Soul Square Bowl
undermounted



UM

Accessories: 8 20 25 40 43 45 61 62

- 72x40x20 h bowl
- equipment: 3½" basket strainer waste, stainless steel drain cover, perimeter overflow
- base unit for bowls: 80
- undermounted: see website

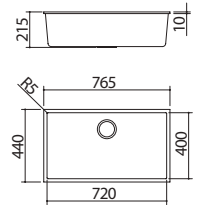

BLACK B_GRANITE

code **1QS081NS**

GREY B_GRANITE

code **1QS081GS**

WHITE B_GRANITE

code **1QS081BS**

Standard equipment: fixing clips, space-saver trap with dishwasher connection, cardboard packaging. The mixer tap is not included.





ACCESSORISED CHANNELS H.7

flat-edge built-in and flush

90 cm built-in and flush channel h.7



120 cm built-in and flush channel h.7



150 cm built-in and flush channel h.7



FEB FT NEW

- extra-thick AISI 304 stainless steel
- designed to accommodate 3 modules
- base unit: 90
- 84x16 cm cut out
flush-top: see website

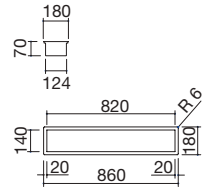

SATIN STAINLESS STEEL

code **1CI97**

FEB FT NEW

- extra-thick AISI 304 stainless steel
- designed to accommodate of 4 modules
- base unit: 120
- 111.5x16 cm cut out
flush-top: see website

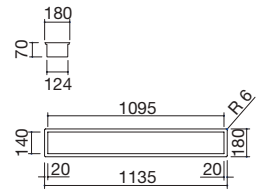

SATIN STAINLESS STEEL

code **1CI127**

FEB FT NEW

- extra-thick AISI 304 stainless steel
- designed to accommodate of 5 modules
- base unit: 150
- 139x16 cm cut out
flush-top: see website

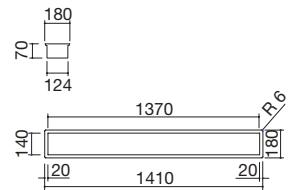

SATIN STAINLESS STEEL

code **1CI157**



ACCESSORISED CHANNELS H.7 flat-edge built-in and flush

180 cm built-in and flush channel h.7



FEB FT NEW

- extra-thick AISI 304 stainless steel
- designed to accommodate of 6 modules
- included: movable shelf 10x13.8 cm
- base unit: 180
- 176x16 cm cut out flush-top: see website

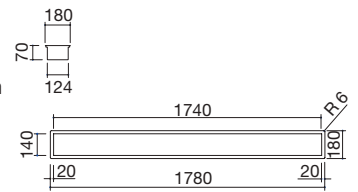

SATIN STAINLESS STEEL

code 1C1187

Standard equipment: fixing clips, cardboard packaging.



ACCESSORISED CHANNELS H.7

flat-edge built-in and flush

90 cm built-in and flush channel h.7



120 cm built-in and flush channel h.7



150 cm built-in and flush channel h.7



FEB FT NEW

- extra-thick AISI 304 stainless steel
- designed to accommodate 3 modules
- base unit: 90
- 84x16 cm cut out
flush-top: see website

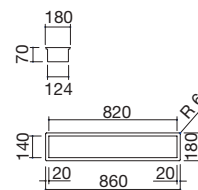

MATT BLACK STAINLESS STEEL

code 1C197N

FEB FT NEW

- extra-thick AISI 304 stainless steel
- designed to accommodate of 4 modules
- base unit: 120
- 111.5x16 cm cut out
flush-top: see website

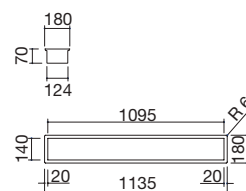

MATT BLACK STAINLESS STEEL

code 1C1127N

FEB FT NEW

- extra-thick AISI 304 stainless steel
- designed to accommodate of 5 modules
- base unit: 150
- 139x16 cm cut out
flush-top: see website

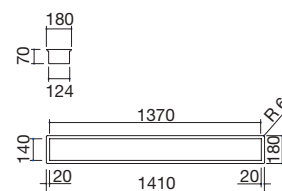

MATT BLACK STAINLESS STEEL

code 1C1157N



ACCESSORISED CHANNELS H.7 flat-edge built-in and flush

180 cm built-in and flush channel h.7



FEB FT NEW

- extra-thick AISI 304 stainless steel
- designed to accommodate of 6 modules
- included: movable shelf 10x13.8 cm
- base unit: 180
- 176x16 cm cut out flush-top: see website

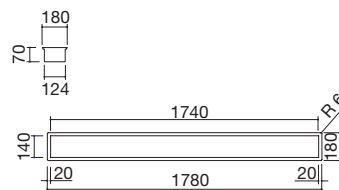

MATT BLACK STAINLESS STEEL

code 1CI187N

Standard equipment: fixing clips, cardboard packaging.





ACCESSORISED CHANNELS H.7 FOR LAB EVOLUTION COOKER HOOD flat-edge built-in and flush

180 cm built-in and flush channel h.7
for Lab Evolution cooker hood

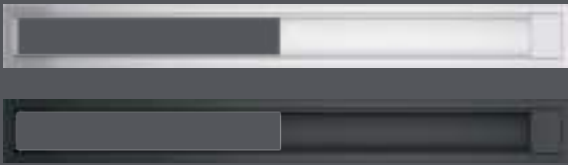

Lab Evolution downdraft cooker hood
for channel

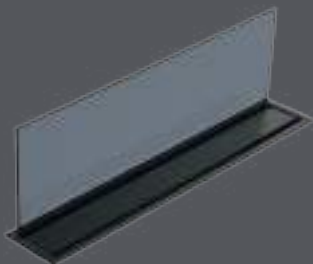

Remote control included



FEB FT NEW

- extra-thick AISI 304 stainless steel designed to accommodate 3 modules plus a cooker hood module to the left or right
- included: movable shelf 7.5x13.8 cm
- 176x16 cm cut out flush-top: see website
- the channel is reversible

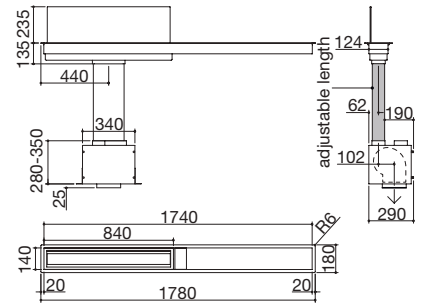

SATIN STAINLESS STEEL

code 1CKI187

MATT BLACK STAINLESS STEEL

code 1CKI187N

Standard equipment: fixing clips, cardboard packaging.

NEW

Accessories: 41

- matt black AISI 304 stainless steel
- fixed deflector glass
- optional filter extraction
- speed: 3+1
- pressure: 334 Pa
- air flow: 800 m³/h
- noise level: 41 - 66 Lw (dBA)
- extractor outlet: ø150 mm + rectangular pipe connector 220x90 mm
- stainless steel filters
- alarm function for filter cleaning
- remote control included
- energy rating C
- set up for remote control from Barazza scales
- compatible with induction hobs with zones in line
- compatible with Barazza gas hobs codes 1PLE2D e 1PLB2T
- maximum absorbed power: 0.275 kW

MATT BLACK STAINLESS STEEL/GREY GLASS code 1CKLE97

Accessories:



41

code 1FC1

ACCESSORISED CHANNELS H.7 modular elements

Stainless steel scales

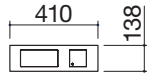

- 1½ modules
- extra-thick AISI 304 stainless steel
- weight range: 0-20 kg
- unit: g, kg, lb, oz
- accuracy: ± 1g
- functions: tare, total, minute minder, multi-timer
- remote control for Barazza cooker hoods
- kitchen light switch 5 A 250 V
- automatic switch-off
- 100-240 V power supply
- maximum absorption 0.2 A

Black stainless steel scales

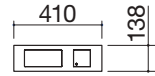

- 1½ modules
- extra-thick AISI 304 stainless steel
- weight range: 0-20 kg
- unit: g, kg, lb, oz
- accuracy: ± 1g
- functions: tare, total, minute minder, multi-timer
- remote control for Barazza cooker hoods
- kitchen light switch 5 A 250 V
- automatic switch-off
- 100-240 V power supply
- maximum absorption 0.2 A

SATIN STAINLESS STEEL

code 1CBL

MATT BLACK STAINLESS STEEL

code 1CBLN

Stainless steel container tray with Fenix knife holder

NEW

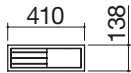

- 1½ modules
- extra-thick AISI 304 stainless steel
- Black Fenix
- designed for 3 knives

Black stainless steel container tray with Fenix knife holder

NEW



- 1½ modules
- extra-thick AISI 304 stainless steel
- Black Fenix
- designed for 3 knives

SATIN FINISH STAINLESS STEEL/FENIX

code 1CVP

MATT BLACK STAINLESS STEEL/FENIX

code 1CVPN

Stainless steel container tray with base

NEW



- 1½ modules
- extra-thick AISI 304 stainless steel

Black stainless steel container tray with base

NEW



- 1½ modules
- extra-thick AISI 304 stainless steel

SATIN STAINLESS STEEL

code 1CVFG

MATT BLACK STAINLESS STEEL

code 1CVFGN

Stainless steel rotating socket holder

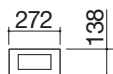

- 1 module
- extra-thick AISI 304 stainless steel cover with 180° rotating system
- 2 Schuko sockets
- 1 USB socket to power electronic devices

Black stainless steel rotating socket holder

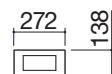

- 1 module
- extra-thick AISI 304 stainless steel cover with 180° rotating system
- 2 Schuko sockets
- 1 USB socket to power electronic devices

SATIN STAINLESS STEEL

code 1CPP

MATT BLACK STAINLESS STEEL

code 1CPPN

ACCESSORISED CHANNELS H.7 modular elements

Stainless steel container tray with base

NEW

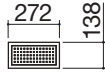

- 1 module
- extra-thick AISI 304 stainless steel

Black stainless steel container tray with base

NEW

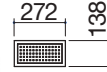

- 1 module
- extra-thick AISI 304 stainless steel

SATIN STAINLESS STEEL

code 1CVF

MATT BLACK STAINLESS STEEL

code 1CVFN

Stainless steel container tray with Fenix draining rack with pegs

NEW

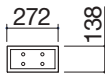

- 1 module
- extra-thick AISI 304 stainless steel
- designed for 3 plates or soup bowls

Black stainless steel container tray with Fenix draining rack with pegs

NEW

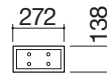

- 1 module
- extra-thick AISI 304 stainless steel
- designed for 3 plates or soup bowls

SATIN FINISH STAINLESS STEEL/FENIX

code 1CSPF

MATT BLACK STAINLESS STEEL/FENIX

code 1CSPFN

Stainless steel container tray with cover

NEW

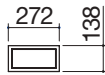

- 1 module
- extra-thick AISI 304 stainless steel cover with push-pull opening mechanism

Black stainless steel container tray with cover

NEW

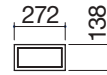

- 1 module
- extra-thick AISI 304 stainless steel cover with push-pull opening mechanism

SATIN STAINLESS STEEL

code 1CVCC

MATT BLACK STAINLESS STEEL

code 1CVCCN

Stainless steel support for mixer tap/dispenser/pull-out spray head

NEW

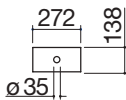

- 1 module
- extra-thick AISI 304 stainless steel
- fixing for tap/dispenser/spray
- installation: see website

Black stainless steel support for mixer tap/dispenser/pull-out spray head

NEW

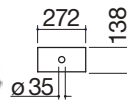

- 1 module
- extra-thick AISI 304 stainless steel
- fixing for tap/dispenser/spray
- installation: see website

SATIN STAINLESS STEEL

code 1CSR7

MATT BLACK STAINLESS STEEL

code 1CSR7N

ACCESSORISED CHANNELS H.7 modular elements

Stainless steel induction charger

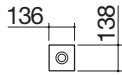

- ½ module
- extra-thick AISI 304 stainless steel
- functions: supports fast charging, high efficiency charging (79%), LED warning light, selective device detection, safety switch-off
- input: 110-240 V ac, 50/60 Hz
- output: 5 V / 9 V - 1.1 A
- max. power: 10 W

SATIN STAINLESS STEEL

code **1CCB**

Black stainless steel induction charger

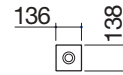

- ½ module
- extra-thick AISI 304 stainless steel
- functions: supports fast charging, high efficiency charging (79%), LED warning light, selective device detection, safety switch-off
- input: 110-240 V ac, 50/60 Hz
- output: 5 V / 9 V - 1.1 A
- max. power: 10 W

MATT BLACK STAINLESS STEEL

code **1CCBN**

Stainless steel Bluetooth speaker

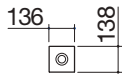

- ½ module
- extra-thick AISI 304 stainless steel
- functions: Bluetooth 5.0, 5-band digital hardware equaliser
- Bluetooth field: 10 m
- input: 110-240 V ac, 50/60 Hz
- max. power: 3 W

SATIN STAINLESS STEEL

code **1CCA**

Black stainless steel Bluetooth speaker

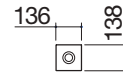
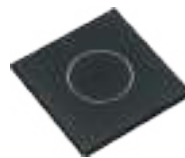

- ½ module
- extra-thick AISI 304 stainless steel
- functions: Bluetooth 5.0, 5-band digital hardware equaliser
- Bluetooth field: 10 m
- input: 110-240 V ac, 50/60 Hz
- max. power: 3 W

MATT BLACK STAINLESS STEEL

code **1CCAN**

Stainless steel container tray with base

NEW

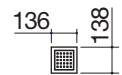

- ½ module
- extra-thick AISI 304 stainless steel

SATIN STAINLESS STEEL

code **1CVFP**

Black stainless steel container tray with base

NEW

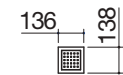

- ½ module
- extra-thick AISI 304 stainless steel

MATT BLACK STAINLESS STEEL

code **1CVFPN**

Stainless steel support for mixer tap/dispenser/pull-out spray head

NEW

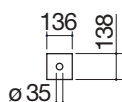

- ½ module
- extra-thick AISI 304 stainless steel
- fixing for tap/dispenser/spray
- installation: see website

SATIN STAINLESS STEEL

code **1CSR7**

Black stainless steel support for mixer tap/dispenser/pull-out spray head

NEW

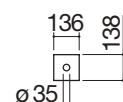

- ½ module
- extra-thick AISI 304 stainless steel
- fixing for tap/dispenser/spray
- installation: see website

MATT BLACK STAINLESS STEEL

code **1CSR7N**

ACCESSORISED CHANNELS H.7 modular elements

Max Steel mixer tap

NEW



- ceramic disc cartridge
- mixer tap rotation: 360°
- mixer tap base: \varnothing 50 mm
- mixer tap hole: \varnothing 35 mm

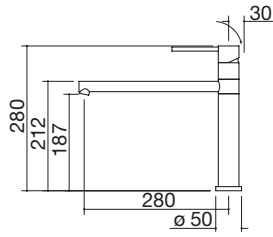

Max Black mixer tap

NEW



- ceramic disc cartridge
- mixer tap rotation: 360°
- mixer tap base: \varnothing 50 mm
- mixer tap hole: \varnothing 35 mm

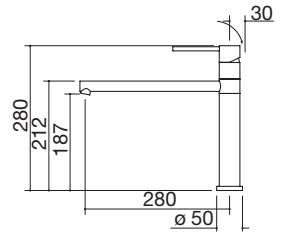

SATIN STAINLESS STEEL FINISH

code 1RUBMXS

BLACK

code 1RUBMXK

Smart Steel dispenser

NEW



- AISI 304 stainless steel
- dispenser with liquid soap/detergent holder, filled from the top, with a capacity of 250 ml
- container dimensions: \varnothing 56x150 h mm
- dispenser base: \varnothing 40 mm
- dispenser hole: \varnothing 35 mm

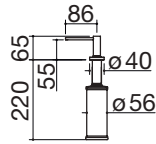

Smart Black dispenser

NEW



- dispenser with liquid soap/detergent holder, filled from the top, with a capacity of 250 ml
- container dimensions: \varnothing 56x150 h mm
- dispenser base: \varnothing 40 mm
- dispenser hole: \varnothing 35 mm

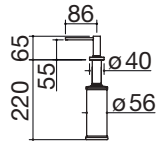

SATIN STAINLESS STEEL

code 1DSS

BLACK

code 1DSK

Pull-out spray head



- pull-out spray head
- compatible with: standard mixer tap, remote control mixer tap, independently powered
- spray head base: \varnothing 55 mm
- spray head hole: \varnothing 35 mm

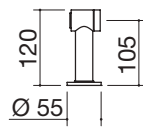

SATIN STAINLESS STEEL FINISH

code 1DCE



ACCESSORISED CHANNELS H.20

flat edge built-in, flush and built-in

90 cm built-in and flush channel h.20



120 cm built-in and flush channel h.20



150 cm built-in and flush channel h.20



180 cm built-in channel



- extra-thick AISI 304 stainless steel
- bowl with 2" drain
- designed to accommodate of 3 modules
- 3 cable outlet holes
- base unit: 90
- 84x16 cm cut out flush-top: see website

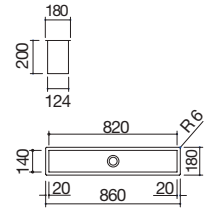

SATIN STAINLESS STEEL

code 1C190



- extra-thick AISI 304 stainless steel
- bowl with 2" drain
- designed to accommodate of 4 modules
- 3 cable outlet holes
- base unit: 120
- 111.5x16 cm cut out flush-top: see website

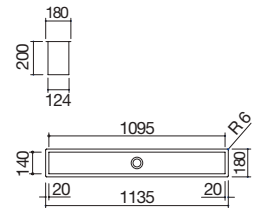

SATIN STAINLESS STEEL

code 1C120



- extra-thick AISI 304 stainless steel
- bowl with 2" drain
- designed to accommodate of 5 modules
- 3 cable outlet holes
- base unit: 150
- 139x16 cm cut out flush-top: see website

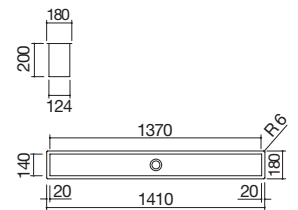

SATIN STAINLESS STEEL

code 1C150

- extra-thick AISI 304 stainless steel
- bowl with 2" drain
- designed to accommodate of 6 modules
- 5 cable outlet holes
- brackets for attaching to wall
- included: movable shelf 10x13.8 cm
- 178x18 cm cut out
- 178x19 cm wall

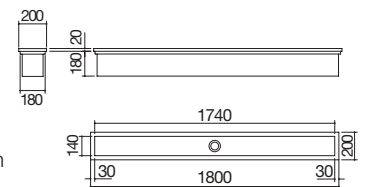

SATIN STAINLESS STEEL

code 1CIA180

Standard equipment: fixing clips, cardboard packaging.

ACCESSORISED CHANNELS H.20

flat edge built-in, flush

90 cm built-in and flush channel h.20



120 cm built-in and flush channel h.20



150 cm built-in and flush channel h.20



- extra-thick AISI 304 stainless steel
- bowl with 2" drain
- designed to accommodate of 3 modules
- 3 cable outlet holes
- base unit: 90
- 84x16 cm cut out flush-top: see website

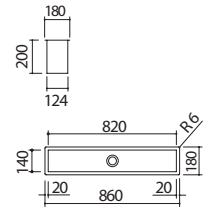

MATT BLACK STAINLESS STEEL

code **1CI90N**



- extra-thick AISI 304 stainless steel
- bowl with 2" drain
- designed to accommodate of 4 modules
- 3 cable outlet holes
- base unit: 120
- 111.5x16 cm cut out flush-top: see website

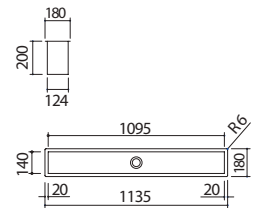

MATT BLACK STAINLESS STEEL

code **1CI120N**



- extra-thick AISI 304 stainless steel
- bowl with 2" drain
- designed to accommodate of 5 modules
- 3 cable outlet holes
- base unit: 150
- 139x16 cm cut out flush-top: see website

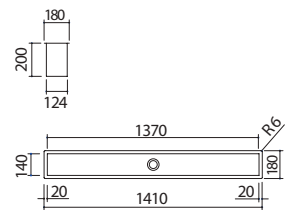

MATT BLACK STAINLESS STEEL

code **1CI150N**

Standard equipment: fixing clips, cardboard packaging.



ACCESSORISED CHANNELS H.20 modular elements

Stainless steel scales

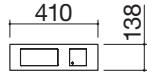

- 1½ modules
- extra-thick AISI 304 stainless steel
- weight range: 0-20 kg
- unit: g, kg, lb, oz
- accuracy: ± 1g
- functions: tare, total, minute minder, multi-timer
- remote control for Barazza cooker hoods
- kitchen light switch 5 A 250 V
- automatic switch-off
- 100-240 V power supply
- maximum absorption 0.2 A

Black stainless steel scales

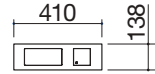

- 1½ modules
- extra-thick AISI 304 stainless steel
- weight range: 0-20 kg
- unit: g, kg, lb, oz
- accuracy: ± 1g
- functions: tare, total, minute minder, multi-timer
- remote control for Barazza cooker hoods
- kitchen light switch 5 A 250 V
- automatic switch-off
- 100-240 V power supply
- maximum absorption 0.2 A

SATIN STAINLESS STEEL

code 1CBL

MATT BLACK STAINLESS STEEL

code 1CBLN

Stainless steel Ice bucket and bottle holder container tray

NEW

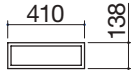

- 1½ modules
- extra-thick AISI 304 stainless steel

Black stainless steel Ice bucket and bottle holder container tray

NEW

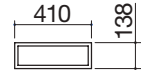

- 1½ modules
- extra-thick AISI 304 stainless steel

SATIN STAINLESS STEEL

code 1CVBG2

MATT BLACK STAINLESS STEEL

code 1CVBG2N

Stainless steel container tray with Fenix knife holder

NEW



- 1½ modules
- extra-thick AISI 304 stainless steel
- Black Fenix designed for 3 knives

Black stainless steel container tray with Fenix knife holder

NEW



- 1½ modules
- extra-thick AISI 304 stainless steel
- Black Fenix designed for 3 knives

SATIN FINISH STAINLESS STEEL/FENIX

code 1CVP

MATT BLACK STAINLESS STEEL/FENIX

code 1CVPN

Stainless steel container tray with base

NEW

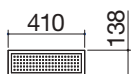

- 1½ modules
- extra-thick AISI 304 stainless steel

Black stainless steel container tray with base

NEW

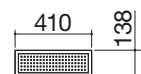

- 1½ modules
- extra-thick AISI 304 stainless steel

SATIN STAINLESS STEEL

code 1CVFG

MATT BLACK STAINLESS STEEL

code 1CVFGN

ACCESSORISED CHANNELS H.20 modular elements

Stainless steel rotating socket holder

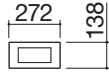

- 1 module
- extra-thick AISI 304 stainless steel cover with 180° rotating system
- 2 Schuko sockets
- 1 USB socket to power electronic devices

Black stainless steel rotating socket holder

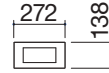

- 1 module
- extra-thick AISI 304 stainless steel cover with 180° rotating system
- 2 Schuko sockets
- 1 USB socket to power electronic devices

SATIN STAINLESS STEEL

code 1CPP

MATT BLACK STAINLESS STEEL

code 1CPPN

Stainless steel chopping board holder with Fenix chopping boards

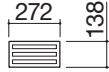

- 1 module
- extra-thick AISI 304 stainless steel
- 3 black Fenix chopping boards

Black stainless steel chopping board holder with Fenix chopping boards

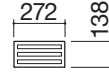

- 1 module
- extra-thick AISI 304 stainless steel
- 3 black Fenix chopping boards

SATIN STAINLESS STEEL / FENIX CHOPPING BOARDS code 1CPT

MATT BLACK STAINLESS STEEL / FENIX CHOPPING BOARDS code 1CPTN

Stainless steel draining rack

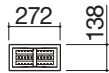

- 1 module
- extra-thick AISI 304 stainless steel
- designed for 3 plates or soup bowls

Black stainless steel and Fenix draining rack with pegs

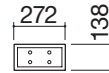

- 1 module
- extra-thick AISI 304 stainless steel
- designed for 3 plates or soup bowls

SATIN STAINLESS STEEL

code 1CSP

MATT BLACK STAINLESS STEEL/FENIX

code 1CSPN

Stainless steel colander

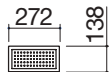

- 1 module
- extra-thick AISI 304 stainless steel

Black stainless steel colander

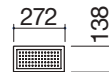

- 1 module
- extra-thick AISI 304 stainless steel

SATIN STAINLESS STEEL

code 1CVS

MATT BLACK STAINLESS STEEL

code 1CVSN

ACCESSORISED CHANNELS

H.20

modular elements

Stainless steel container tray with base

NEW

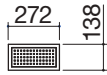

- 1 module
- extra-thick AISI 304 stainless steel

Black stainless steel container tray with base

NEW

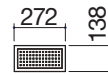

- 1 module
- extra-thick AISI 304 stainless steel

SATIN STAINLESS STEEL

code 1CVF

MATT BLACK STAINLESS STEEL

code 1CVFN

Stainless steel shelf / glass drainer

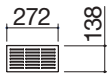

- 1 module
- extra-thick AISI 304 stainless steel



Black stainless steel shelf / glass drainer

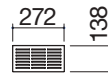

- 1 module
- extra-thick AISI 304 stainless steel



SATIN STAINLESS STEEL

code 1CRG

MATT BLACK STAINLESS STEEL

code 1CRGN

Fenix knife holder

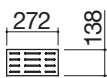

- 1 module
- Black Fenix
- designed for 12 knives



Black stainless steel support for tablet and smartphone



- extra-thick AISI 304 stainless steel
- compatible with codes 1CRG, 1CRGN, 1CPC, 1CRP, 1CRPN

FENIX

code 1CPC

MATT BLACK STAINLESS STEEL

code 1CSTN

Stainless steel container tray with cover

NEW

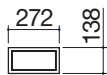

- 1 module
- extra-thick AISI 304 stainless steel cover with push-pull opening mechanism

Black stainless steel container tray with cover

NEW

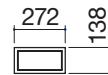

- 1 module
- extra-thick AISI 304 stainless steel cover with push-pull opening mechanism

SATIN STAINLESS STEEL

code 1CVCC

MATT BLACK STAINLESS STEEL

code 1CVCCN

ACCESSORISED CHANNELS H.20 modular elements

Stainless steel induction charger

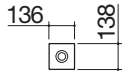

- 1/2 module
- extra-thick AISI 304 stainless steel
- functions: supports fast charging, high efficiency charging (79%), LED warning light, selective device detection, safety switch-off
- input: 110-240 V ac, 50/60 Hz
- output: 5 V / 9 V - 1.1 A
- max. power: 10 W

SATIN STAINLESS STEEL

code **1CCB**

Black stainless steel induction charger

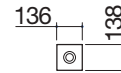

- 1/2 module
- extra-thick AISI 304 stainless steel
- functions: supports fast charging, high efficiency charging (79%), LED warning light, selective device detection, safety switch-off
- input: 110-240 V ac, 50/60 Hz
- output: 5 V / 9 V - 1.1 A
- max. power: 10 W

MATT BLACK STAINLESS STEEL

code **1CCBN**

Stainless steel Bluetooth speaker

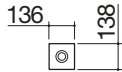

- 1/2 module
- extra-thick AISI 304 stainless steel
- functions: Bluetooth 5.0, 5-band digital hardware equaliser
- Bluetooth field: 10 m
- input: 110-240 V ac, 50/60 Hz
- max. power: 3 W

SATIN STAINLESS STEEL

code **1CCA**

Black stainless steel Bluetooth speaker

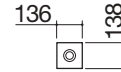

- 1/2 module
- extra-thick AISI 304 stainless steel
- functions: Bluetooth 5.0, 5-band digital hardware equaliser
- Bluetooth field: 10 m
- input: 110-240 V ac, 50/60 Hz
- max. power: 3 W

MATT BLACK STAINLESS STEEL

code **1CCAN**

Stainless steel bottle holder

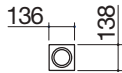

- 1/2 module
- extra-thick AISI 304 stainless steel
- designed for different utensils or bottle max. diameter 90 mm

SATIN STAINLESS STEEL

code **1CPB**

Black stainless steel bottle holder

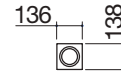

- 1/2 module
- extra-thick AISI 304 stainless steel
- designed for different utensils or bottle max. diameter 90 mm

MATT BLACK STAINLESS STEEL

code **1CPBN**

Stainless steel shelf / glass drainer

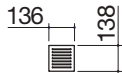

- 1/2 module
- extra-thick AISI 304 stainless steel



SATIN STAINLESS STEEL

code **1CRP**

Black stainless steel shelf / glass drainer

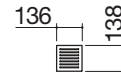

- 1/2 module
- extra-thick AISI 304 stainless steel



MATT BLACK STAINLESS STEEL

code **1CRPN**

ACCESSORISED CHANNELS H.20 modular elements

Stainless steel container tray with base

NEW



136



- 1/2 module
- extra-thick AISI 304 stainless steel

Black stainless steel container tray with base

NEW



136



- 1/2 module
- extra-thick AISI 304 stainless steel

SATIN STAINLESS STEEL

code 1CVFP

MATT BLACK STAINLESS STEEL

code 1CVFPN



ACCESSORISED CHANNELS H.7

EXAMPLES OF COMPOSITION

Matt black stainless steel and satin stainless steel

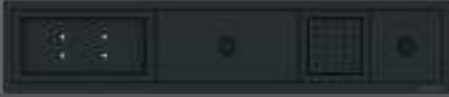

90 cm built-in and flush accessorised channel with 2 x 1-module elements and 2 x 1/2-module elements



150 cm built-in and flush accessorised channel with 3 x 1-module elements and 4 x 1/2-module elements



180 cm built-in and flush accessorised channel with 1 x 1 1/2-module element, 1 x 1-module element, 1 x 1/2-module element, Lab Evolution cooker hood with 3 modules and movable shelf

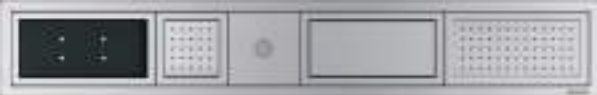

120 cm built-in and flush accessorised channel with 3 x 1-module elements and 2 x 1/2-module elements



180 cm built-in and flush accessorised channel with 1 x 1 1/2-module element, 3 x 1-module elements, 3 x 1/2-module elements and movable shelf



180 cm built-in and flush accessorised channel with 1 x 1 1/2-module element, 1 x 1-module element, 1 x 1/2-module element, Lab Evolution cooker hood with 3 modules and mobile tray



180 cm built-in and flush accessorised channel with 2 x 1-module elements, 2 x 1/2-module elements, Lab Evolution cooker hood with 3 modules and movable shelf

ACCESSORISED CHANNELS H.20

EXAMPLES OF COMPOSITION

Matt black stainless steel and satin stainless steel



90 cm built-in and flush accessorised channel with 2 x 1-module elements and 2 x 1/2-module elements



120 cm built-in and flush accessorised channel with 1 x 1 1/2-module elements, 2 x 1-module element and 1 x 1/2-module element



120 cm built-in and flush accessorised channel with 2 x 1-module elements and 4 x 1/2-module elements



150 cm built-in and flush accessorised channel with 1 x 1 1/2-module elements, 3 x 1-module element and 1 x 1/2-module element



150 cm built-in and flush accessorised channel with 2 x 1 1/2-module elements, 2 x 1-module elements



180 cm accessorised channel for insertion with 4 x 1-module elements and 4 x 1/2-module elements and movable shelf

THALAS HOBS FREESTANDING

40 cm freestanding Thalass hob double ring 4.7 kW



40 cm freestanding Thalass hob 1 gas burner + Chef double ring



40 cm freestanding Thalass hob 2 induction zones



Accessories: 35

- extra-thick AISI 316 stainless steel
- cast iron pan support
- burner with dual control
- equipment: electronic activation with battery
- provision for LPG power supply
- waterproof cover

Burner power:

- 1 double ring: 4.7 kW
- (central 0.8 kW and 3.9 kW ring)

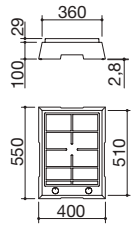

SATIN AISI 316 STAINLESS STEEL

code 1PTF1



- extra-thick AISI 316 stainless steel
- cast iron pan support
- equipment: electronic activation with battery
- provision for LPG power supply
- waterproof cover

Burner power:

- 1 semi-rapid: 1.75 kW
- 1 Chef double ring: 3.5 kW

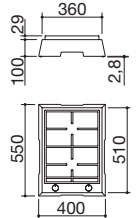

SATIN AISI 316 STAINLESS STEEL

code 1PTF2



- extra-thick AISI 316 stainless steel
- functions: power management, Booster, selective pan detection, keep warm, automatic preheating
- safety devices: electronic child-safety lock, residual heat indicator, safety switch-off
- minimum pan diameter: \varnothing 90 mm
- adjustable power levels: 1.6 – 2.0 – 2.4 – 2.8 – 3.2 – 3.7 kW
- maximum absorbed power: 3.7 kW
- equipment: Schuko mains plug
- waterproof cover
- Thalass 1TTH chopping board

Induction zone power:

- 1 zone \varnothing 200 mm: 2.3-3 kW (*)
- 1 zone \varnothing 160 mm: 1.4-2.1 kW (*)
- (*) with Booster function

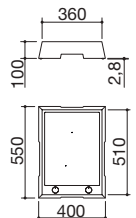

BLACK GLASS CERAMIC/SATIN FINISH
AIS I 316 STAINLESS STEEL

code 1PTFID



THALAS HOBS FREESTANDING

40 cm freestanding Thalass hob teppanyaki



40 cm freestanding Thalass hob barbecue



Thalass multipurpose cover waterproof cover / serving tray



- extra-thick AISI 316 stainless steel
- AISI 304 stainless steel single hotplate, 6 mm thick
- thermostat
- 2 cooking zones
- electronic temperature control from 50 °C to 270 °C
- hotplate activation indicator and thermostat
- maximum absorbed power: 1 kW
- equipment: Schuko mains plug
- waterproof cover
- Thalass 1TTH chopping board

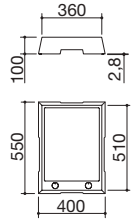

SATIN AISI 316 STAINLESS STEEL

code 1PTFTK1



- extra-thick AISI 316 stainless steel
- barbecue with electric element
- cast iron grid
- lava stone to absorb cooking liquids
- AISI 304 stainless steel removable tray
- settings 0 to 9
- heating element activation indicator
- maximum absorbed power: 1.75 kW
- equipment: Schuko mains plug
- waterproof cover

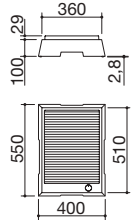

SATIN AISI 316 STAINLESS STEEL

code 1PTFBQ



Accessories: **73**

- extra-thick AISI 316 stainless steel
- dual function: cover and serving tray
- compatible with all freestanding and built-in Thalass hobs
- compatible with waterproof cover

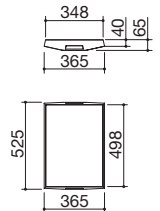

SATIN AISI 316 STAINLESS STEEL

code 1C306

Accessories:



35

code 1RWJ



73

code 1TTH



BUILT-IN THALAS HOBS

37 cm built-in Thalys hob

double ring 4.7 kW



37 cm built-in Thalys hob

1 gas burners + Chef double ring



37 cm built-in Thalys hob

2 induction zones

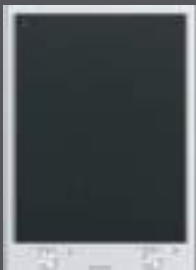

Accessories: 35

- extra-thick AISI 316 stainless steel
- cast iron pan support
- burner with dual control
- equipment: electronic activation with battery, fixing clips, seal
- provision for LPG power supply
- waterproof cover
- 34x49 cm cut out

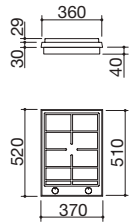

- **Burner power:**
- 1 double ring 4.7 kW
- (central 0.8 kW and ring 3.9 kW)

SATIN AISI 316 STAINLESS STEEL

code 1PT11



- extra-thick AISI 316 stainless steel
- cast iron pan support
- equipment: electronic activation with battery, fixing clips, seal
- provision for LPG power supply
- waterproof cover
- 34x49 cm cut out

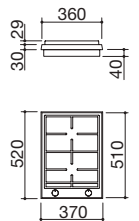

- **Burner power:**
- 1 semi-rapid: 1.75 kW
- 1 Chef double ring: 3.5 kW

SATIN AISI 316 STAINLESS STEEL

code 1PT12

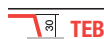

- extra-thick AISI 316 stainless steel
- functions: power management, Booster, selective pan detection, automatic preheating, keep warm
- safety devices: electronic child-safety lock, residual heat indicator, safety switch-off
- minimum pan diameter: \varnothing 90 mm
- adjustable power levels: 1.6 - 2.0 - 2.4 - 2.8 - 3.2 - 3.7 kW
- maximum absorbed power: 3.7 kW
- equipment: Schuko mains plug, fixing clips, seal
- waterproof cover
- Thalys 1TTH chopping board
- 34x49 cm cut out

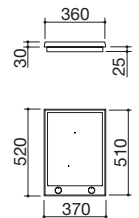

- **Induction zone power:**
- 1 zone \varnothing 200 mm: 2.3-3 kW (*)
- 1 zone \varnothing 160 mm: 1.4-2.1 kW (*)
- (*) with Booster function

BLACK GLASS CERAMIC/SATIN FINISH
AISII 316 STAINLESS STEEL

code 1PTIID



BUILT-IN THALAS HOBS

37 cm built-in Thalys hob teppanyaki



80 cm built-in Thalys hob teppanyaki



37 cm built-in Thalys hob barbecue



70 cm built-in Thalys hob barbecue

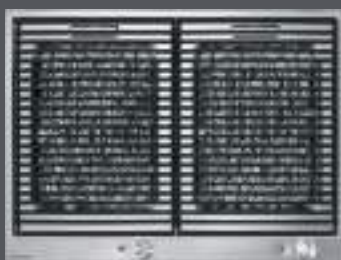

TEB NEW

- extra-thick AISI 316 stainless steel
- 6 mm AISI 304 stainless steel single hotplate
- thermostat
- 2 cooking zones
- electronic temperature control from 50 °C to 270 °C
- hotplate activation indicator and thermostat
- maximum absorbed power: 1 kW
- equipment: Schuko mains plug, fixing clips, seal
- waterproof cover
- Thalys 1TTH chopping board
- 34x49 cm cut out

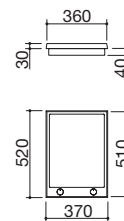

SATIN AISI 316 STAINLESS STEEL

code 1PTITK1

TEB NEW

Accessories: 81

- extra-thick AISI 316 stainless steel
- 6 mm AISI 304 stainless steel single hotplate
- double thermostat
- 2 cooking zones
- electronic temperature control from 50 °C to 270 °C
- hotplate activation indicator and thermostat
- equipment: Schuko mains plug, removable liquid collection container, fixing clips, seal
- waterproof cover
- maximum absorbed power: 2 kW
- 76x49 cm cut out

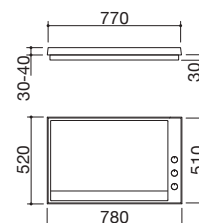

SATIN AISI 316 STAINLESS STEEL

code 1PTI8TK

TEB

- extra-thick AISI 316 stainless steel
- barbecue with electric element
- cast iron grid
- lava stone to absorb cooking liquids
- AISI 304 stainless steel removable tray
- settings 0 to 9
- heating element activation indicator
- maximum absorbed power: 1.75 kW
- equipment: Schuko mains plug, fixing clips, seal
- waterproof cover
- 34x49 cm cut out

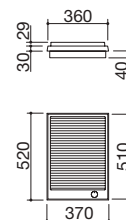

SATIN AISI 316 STAINLESS STEEL

code 1PTIBQ

TEB NEW

- extra-thick AISI 316 stainless steel
- barbecue with electric element
- cast iron grid
- 2 cooking zones
- lava stone to absorb cooking liquids
- AISI 304 stainless steel removable trays
- settings 0 to 9
- heating element activation indicator
- equipment: Schuko mains plug, fixing clips, seal
- waterproof cover
- maximum absorbed power: 3.5 kW
- 66.5x49 cm cut out

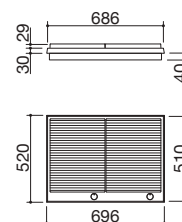

SATIN AISI 316 STAINLESS STEEL

code 1PTI7BQ

BUILT-IN THALAS HOBS

Thalas multipurpose cover
waterproof cover / serving tray



Accessories: **73**

- extra-thick AISI 316 stainless steel
- dual function: cover and serving tray
- compatible with all freestanding and built-in Thalas hobs
- compatible with waterproof cover

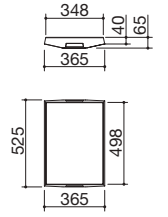

SATIN AISI 316 STAINLESS STEEL

code 1C306

Accessories:



35

code 1RWJ



73

code 1TTH



81

code 1PST



LAB 316 SINKS WITH LOWERING flat edge built-in, flush and undermounted

57x51 cm Lab 316 built-in, flush and undermounted sink
1 bowl with lowering



86x51 cm Lab 316 built-in, flush and undermounted sink
1 bowl with lowering



FEB FT UM

Accessories: 6 19 71

- extra-thick AISI 316 stainless steel
- bowl with radius "0"
- 54x38.8x18.3 h bowl
- bowl with lowering for sliding of accessories
- equipment: 3½" basket strainer waste, stainless steel drain cover, Smart pop-up plug,
- B overflow
- tap hole: 2 holes as standard
- base unit for bowls:
 - built-in and flush: 60
 - undermounted: 80
- 56x49 cm cut out
flush-top and undermounted:
see website

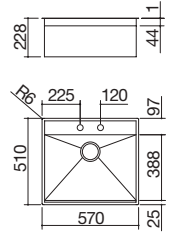

SATIN AISI 316 STAINLESS STEEL

code 1LLB616

FEB FT UM

Accessories: 6 19 67 71

- extra-thick AISI 316 stainless steel
- bowl with radius "0"
- 83x38.8x18.3 h bowl
- bowl with lowering for sliding of accessories
- equipment: 3½" basket strainer waste, stainless steel drain cover, Smart pop-up plug,
- B overflow
- tap hole: 2 holes as standard
- base unit for bowls:
 - built-in and flush: 90
 - undermounted: 100
- 85x49 cm cut out
flush-top and undermounted:
see website

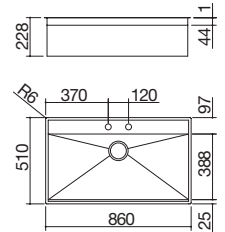

SATIN AISI 316 STAINLESS STEEL

code 1LLB916

Accessories:

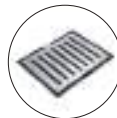

6
code 1TBF



19
code 1VBF



67
code 1GQN

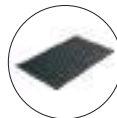

71
code 1GQRN

LAB COVER 316 SINKS

flat-edge built-in and flush

57x51 cm Lab Cover 316 built-in and flush sink
1 bowl with cover + tap



FEB FT

Accessories: 71

- extra-thick AISI 316 stainless steel
- bowl with radius "0"
- 54x34x18.3 h bowl
- balanced, removable, AISI 316 stainless steel cover with manual opening
- equipment: 3½" basket strainer waste, B overflow, Thalys Telescopic mixer tap with remote control 1RUBTH
- tap hole: 2 holes as standard
- base unit for bowls: 60
- 56x49 cm cut out
flush-top: see website

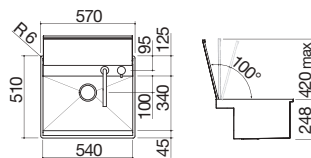

SATIN AISI 316 STAINLESS STEEL

code 1LLB606

Accessories:



71

code 1GQRN



SQUARE BOWLS R. "12" 316 flat-edge built-in, flush and undermounted

40x40 cm square bowl R. "12" 316
built-in, flush and undermounted



50x40 cm square bowl R. "12" 316
built-in, flush and undermounted



70x40 cm square bowl R. "12" 316
built-in, flush and undermounted



FEB FT UM

Accessories: 8 17 20 25 40 43
45 61 62 66 71

- extra-thick AISI 316 stainless steel
- 40x40x20 h cm bowl
- equipment: 3½" basket strainer waste, B overflow
- base unit for bowls:
 - built-in and flush: 50
 - undermounted: 60
- 42x42 cm cut out
+ notch for overflow
flush-top and undermounted:
see website

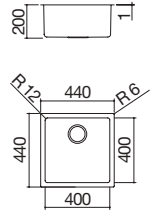

SATIN AISI 316 STAINLESS STEEL

code 1QR406

FEB FT UM

Accessories: 8 17 20 25 40 43
45 61 62 66 71

- extra-thick AISI 316 stainless steel
- 50x40x20 h cm bowl
- equipment: 3½" basket strainer waste, B overflow
- base unit for bowls:
 - built-in and flush: 60
 - undermounted: 80
- 52x42 cm cut out
+ notch for overflow
flush-top and undermounted:
see website

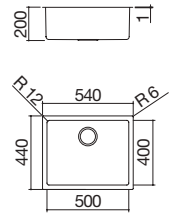

SATIN AISI 316 STAINLESS STEEL

code 1QR506

FEB FT UM

Accessories: 8 17 20 25 40 43
45 61 62 66 71

- extra-thick AISI 316 stainless steel
- 70x40x20 h cm bowl
- equipment: 3½" basket strainer waste, B overflow
- base unit for bowls:
 - built-in and flush: 80
 - undermounted: 90
- 72x42 cm cut out
+ notch for overflow
flush-top and undermounted:
see website

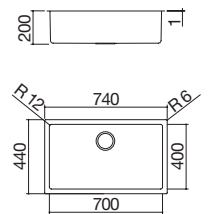

SATIN AISI 316 STAINLESS STEEL

code 1QR706

Accessories:

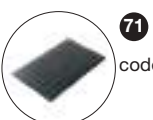
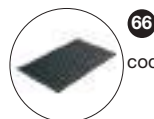
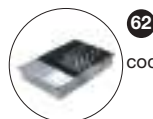
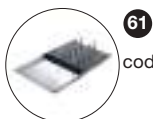
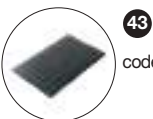
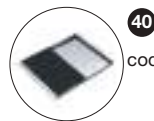
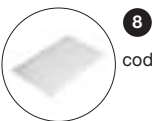

Standard equipment: fixing clips, space-saver trap with dishwasher connection, cardboard packaging. The mixer tap is not included.

MIXER TAPS

single lever

Mood One mixer tap



- AISI 316 stainless steel
- ceramic disc cartridge
- tap rotation: 360°
- tap base: 45x45 mm
- tap hole: \varnothing 35 mm

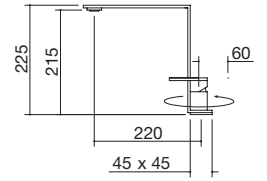

SATIN AISI 316 STAINLESS STEEL

code **1RUBMD1**

Lab In mixer tap



- ceramic disc cartridge
- tap rotation: 360°
- tap base: 50x50 mm
- tap hole: \varnothing 35 mm

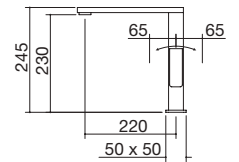

SATIN STAINLESS STEEL FINISH

code **1RUBMLBI**

Mood One mixer tap



Lab In mixer tap



MIXER TAPS

single lever

Select Two mixer tap



Evo Shower mixer tap with double delivery pull-out spray head



Max Steel mixer tap



Select Two mixer tap



Evo Shower mixer tap



Max Steel mixer tap



- ceramic disc cartridge
- tap rotation: 360°
- tap base: \varnothing 50 mm
- tap hole: \varnothing 35 mm

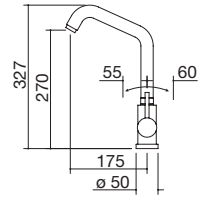

SATIN STAINLESS STEEL FINISH

code 1RUBMS2

- double delivery pull-out spray head
- ceramic disc cartridge
- tap rotation: 360°
- tap base: \varnothing 50 mm
- tap hole: \varnothing 35 mm

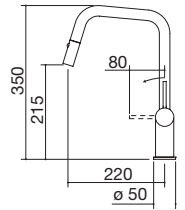

SATIN STAINLESS STEEL FINISH

code 1RUBEVD

- ceramic disc cartridge
- tap rotation: 360°
- tap base: \varnothing 50 mm
- tap hole: \varnothing 35 mm

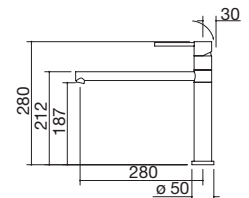

SATIN STAINLESS STEEL FINISH

code 1RUBMXS

MIXER TAPS

single lever

B_Free One mixer tap



B_Fast mixer tap



Lab One Shower mixer tap with pull-out spray head



Lab One Shower mixer tap

- ceramic disc cartridge
- tap rotation: 360°
- tap base: ø 55 mm
- tap hole: ø 35 mm

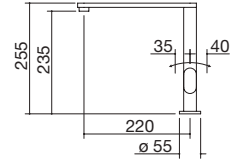

CHROME STAINLESS STEEL FINISH code **1RUBMBF1C**

- ceramic disc cartridge
- tap rotation: 360°
- tap base: ø 50 mm
- tap hole: ø 35 mm

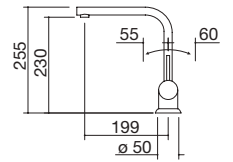

CHROME STAINLESS STEEL FINISH code **1RUBMFSC**

- pull-out spray head
- ceramic disc cartridge
- tap rotation: 360°
- tap base: ø 50 mm
- tap hole: ø 35 mm

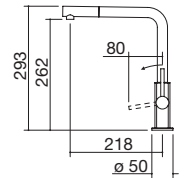

CHROME STAINLESS STEEL FINISH code **1RUBL1D**

B_Fast mixer tap



MIXER TAPS

single lever

B_Level mixer tap



Officina Shower mixer tap
with pull-out spray head



- ceramic disc cartridge
- tap rotation: 360°
- tap base: \varnothing 50 mm
- tap hole: \varnothing 35 mm

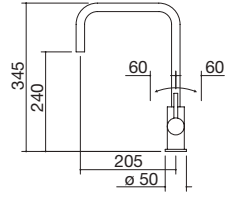

CHROME STAINLESS STEEL FINISH code 1RUBMBLC

- pull-out spray head
- ceramic disc cartridge
- tap rotation: 360°
- tap base: \varnothing 50 mm
- tap hole: \varnothing 35 mm

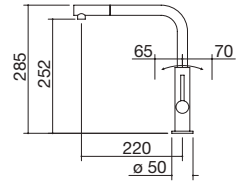

CHROME STAINLESS STEEL FINISH code 1RUBMOF1C

B_Level mixer tap



Officina Shower mixer tap



MIXER TAPS

single lever

Steel One mixer tap



NEW

- AISI 304 stainless steel
- ceramic disc cartridge
- tap rotation: 360°
- tap base: \varnothing 55 mm
- tap hole: \varnothing 35 mm

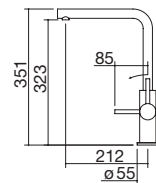

SATIN AISI 304 STAINLESS STEEL

code **1RUBS1**

Steel Shower mixer tap with pull-out spray head



- pull-out spray head
- AISI 304 stainless steel
- ceramic disc cartridge
- tap rotation: 180°
- tap base: \varnothing 50 mm
- tap hole: \varnothing 35 mm

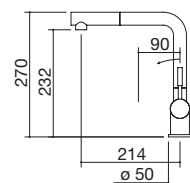

SATIN AISI 304 STAINLESS STEEL

code **1RUBMSTD**

Steel Shower Vintage mixer tap with pull-out spray head



- pull-out spray head
- Vintage AISI 304 stainless steel
- ceramic disc cartridge
- tap rotation: 180°
- tap base: \varnothing 50 mm
- tap hole: \varnothing 35 mm

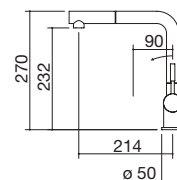

VINTAGE AISI 304 STAINLESS STEEL

code **1RUBMSTDV**



Steel Shower mixer tap



Steel Shower Vintage mixer tap



MIXER TAPS

single lever

Easy Steel mixer tap



B_Free Steel mixer tap



B_Open One Steel mixer tap



- AISI 304 stainless steel
- ceramic disc cartridge
- tap rotation: 360°
- tap base: \varnothing 50 mm
- tap hole: \varnothing 35 mm

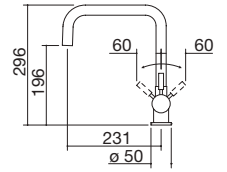

SATIN AISI 304 STAINLESS STEEL

code 1RUBESS

- AISI 304 stainless steel
- ceramic disc cartridge
- tap rotation: 360°
- tap base: \varnothing 50 mm
- tap hole: \varnothing 35 mm

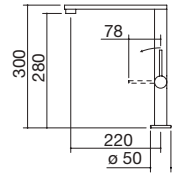

SATIN AISI 304 STAINLESS STEEL

code 1RUBBFS

NEW

- AISI 304 stainless steel
- ceramic disc cartridge
- tap rotation: 360°
- tap base: \varnothing 55 mm
- tap hole: \varnothing 35 mm

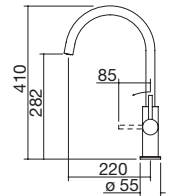

SATIN AISI 304 STAINLESS STEEL

code 1RUBB01S

Easy Steel mixer tap



B_Free Steel mixer tap



B_Open Steel mixer tap



MIXER TAPS

single lever

Select One Shower Steel mixer tap
with pull-out spray head



Officina One Shower Steel mixer tap
with pull-out spray head



Select One Shower Steel mixer tap



NEW

- pull-out spray head
- AISI 304 stainless steel
- ceramic disc cartridge
- tap rotation: 360°
- tap base: \varnothing 55 mm
- tap hole: \varnothing 35 mm

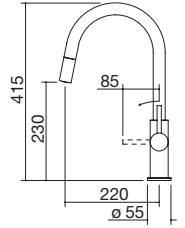

SATIN AISI 304 STAINLESS STEEL

code 1RUBS1DS

NEW

- pull-out spray head
- AISI 304 stainless steel
- ceramic disc cartridge
- tap rotation: 360°
- tap base: \varnothing 55 mm
- tap hole: \varnothing 35 mm

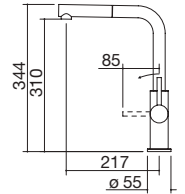

SATIN AISI 304 STAINLESS STEEL

code 1RUBO1DS

Officina One Shower Steel mixer tap



MIXER TAPS single lever

Officina Shower 316 mixer tap
with pull-out spray head



- pull-out spray head
- AISI 316 stainless steel
- ceramic disc cartridge
- tap rotation: 360°
- tap base: \varnothing 45 mm
- tap hole: \varnothing 35 mm

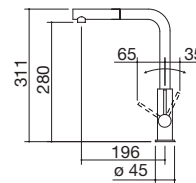

SATIN AISI 316 STAINLESS STEEL

code **1RUBOF316**



MIXER TAPS

single lever

Unique Two mixer tap



Unique Two Shower mixer tap with pull-out spray head



Max Black mixer tap



Unique Two Shower mixer tap



- ceramic disc cartridge
- tap rotation: 360°
- tap base: \varnothing 50 mm
- tap hole: \varnothing 35 mm

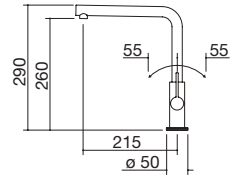

BLACK

code 1RUBUN2

- pull-out spray head
- ceramic disc cartridge
- tap rotation: 360°
- tap base: \varnothing 50 mm
- tap hole: \varnothing 35 mm

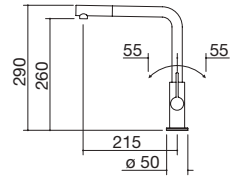

BLACK

code 1RUBUN2D

NEW

- ceramic disc cartridge
- tap rotation: 360°
- tap base: \varnothing 50 mm
- tap hole: \varnothing 35 mm

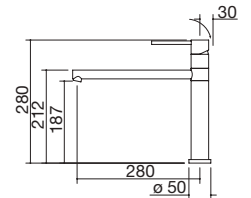

BLACK

code 1RUBMXK

Max Black mixer tap



MIXER TAPS

single lever

City One mixer tap



Evo Shower Black mixer tap
with double dispensing pull-out spray head



City One mixer tap



- ceramic disc cartridge
- tap rotation: 360°
- tap base: \varnothing 50 mm
- tap hole: \varnothing 35 mm

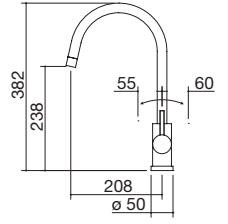

BLACK

code 1RUBCY1

- double dispensing pull-out spray head
- ceramic disc cartridge
- tap rotation: 360°
- tap base: \varnothing 50 mm
- tap hole: \varnothing 35 mm

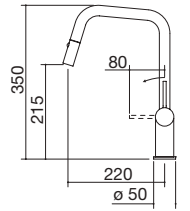

BLACK

code 1RUBEVDK

Evo Shower Black mixer tap



MIXER TAPS single lever

Soul Shower mixer tap
with pull-out spray head



- pull-out spray head
- ceramic disc cartridge
- tap rotation: 360°
- tap base: \varnothing 50 mm
- tap hole: \varnothing 35 mm

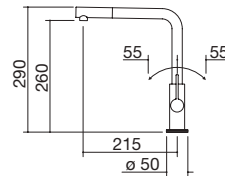

GREY

code **1RUBSODG**

WHITE

code **1RUBSODB**

Soul Shower grey mixer tap



Soul Shower white mixer tap



MIXER TAPS

telescopic

B_Free Telescopic mixer tap

with remote control



B_Open Telescopic mixer tap

with remote control and pull-out spray head



B_Free Telescopic mixer tap



- ceramic disc cartridge
- tap rotation: 360°
- minimum height: 42 mm
- tap base: \varnothing 55 mm
- control base: \varnothing 52 mm
- tap hole: \varnothing 35 mm
- control hole: \varnothing 35 mm

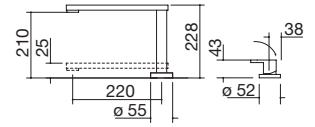

SATIN STAINLESS STEEL FINISH

code 1RUBMBFA

- pull-out spray head
- ceramic disc cartridge
- tap rotation: 360°
- minimum height: 60 mm
- tap base: \varnothing 55 mm
- control base: \varnothing 50 mm
- tap hole: \varnothing 35 mm
- control hole: \varnothing 35 mm

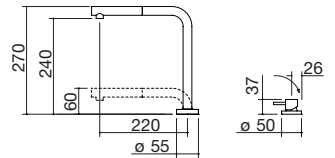

SATIN STAINLESS STEEL FINISH

code 1RUBMBOA

B_Open Telescopic mixer tap



MIXER TAPS

telescopic

Space Telescopic Steel mixer tap with remote control



Thalas Telescopic mixer tap with remote control



B_Smart Telescopic mixer tap



NEW

- AISI 304 stainless steel
- ceramic disc cartridge
- tap rotation: 360°
- minimum height: 40 mm
- tap base: \varnothing 54 mm
- control base: \varnothing 54 mm
- tap hole: \varnothing 35 mm
- control hole: \varnothing 35 mm

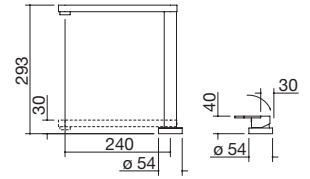

SATIN AISI 304 STAINLESS STEEL

code 1RUBSSA

- AISI 316 stainless steel
- ceramic disc cartridge
- tap rotation: 360°
- minimum height: 45 mm
- tap base: \varnothing 55 mm
- control base: \varnothing 43 mm
- tap hole: \varnothing 35 mm
- control hole: \varnothing 35 mm

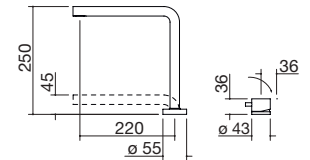

SATIN AISI 316 STAINLESS STEEL

code 1RUBTH

- ceramic disc cartridge
- tap rotation: 360°
- minimum height: 71 mm
- tap base: \varnothing 55 mm
- tap hole: \varnothing 35 mm

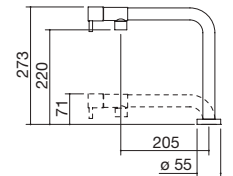

SATIN STAINLESS STEEL FINISH

code 1RUBBSM

Space Telescopic mixer tap



Thalas Telescopic mixer tap



B_Smart Telescopic mixer tap



MIXER TAPS

with remote control and pull-out spray head

Kit Top mixer tap

with remote control and pull-out spray head



B_Free Kit mixer tap

with remote control and pull-out spray head



Mizu Kit Telescopic mixer tap

with remote control and pull-out spray head



- AISI 316 stainless steel
- ceramic disc cartridge
- tap rotation: 360°
- tap base: \varnothing 50 mm
- control base: \varnothing 50 mm
- spray head base: \varnothing 55 mm
- tap hole: \varnothing 35 mm
- control hole: \varnothing 35 mm
- spray head hole: \varnothing 35 mm

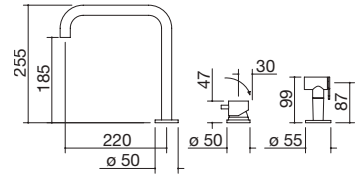

SATIN AISI 316 STAINLESS STEEL

code **1RUBMRKT**

- ceramic disc cartridge
- tap rotation: 360°
- tap base: \varnothing 50 mm
- control base: \varnothing 50 mm
- spray head base: \varnothing 55 mm
- tap hole: \varnothing 35 mm
- control hole: \varnothing 35 mm
- spray head hole: \varnothing 35 mm

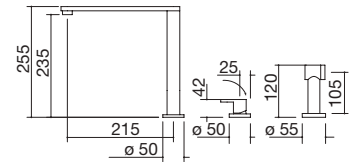

SATIN STAINLESS STEEL FINISH

code **1RUBMBFRK**

- ceramic disc cartridge
- tap rotation: 360°
- minimum height: 40 mm
- tap base: 52x52 mm
- control base: 52x52 mm
- spray-head base: 52x52 mm
- tap hole: \varnothing 35 mm
- control hole: \varnothing 35 mm
- spray head hole: \varnothing 35 mm

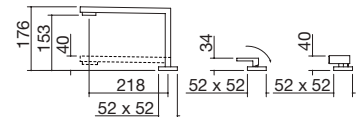

SATIN STAINLESS STEEL FINISH

code **1RUBMZK**

Kit Top mixer tap



B_Free Kit mixer tap



Mizu Kit Telescopic mixer tap





MIXER TAPS remote control

Mood Top mixer tap with remote control



- AISI 316 stainless steel
- ceramic disc cartridge
- tap rotation: 360°
- tap base: 45x45 mm
- control base: 50x50 mm
- tap hole: \varnothing 35 mm
- control hole: \varnothing 35 mm

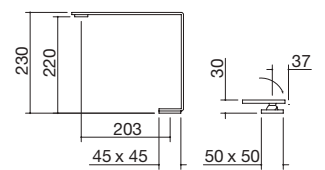

SATIN AISI 316 STAINLESS STEEL

code 1RUBMDT



MIXER TAPS

remote control

Soul mixer tap

remote control and pull-out spray head



- pull-out spray head
- ceramic disc cartridge
- tap rotation: 360°
- tap base: \varnothing 55 mm
- control base: \varnothing 50 mm
- tap hole: \varnothing 35 mm
- control hole: \varnothing 35 mm

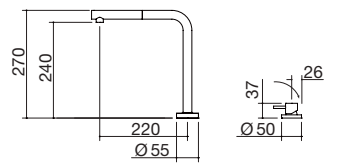

BLACK

code **1RUBSORN**



MIXER TAPS 3-WAY

3-way glass mixer tap



- AISI 316 stainless steel
- ceramic disc cartridge
- tap rotation: 360°
- tap base: \varnothing 50 mm
- tap hole: \varnothing 35 mm

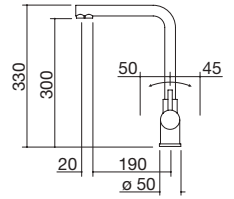

SATIN AISI 316 STAINLESS STEEL

code **1RUBMGL**

Accessories:

Filter (including cartridge)

code **1FGL**

Spare cartridge

code **1CGL**

3-Way Glass mixer tap

Glass is completely made of AISI 316 stainless steel and fulfils two functions in a single item: the delivery of both purified water and normal running water. It lets you use filtered and purified water only when necessary. The system is economical, ecological and safe, designed to guarantee water that is always completely pure, eliminating limescale and chlorine residues, the cause of bad smells. It respects the environment because it substantially reduces the use of plastic, does not generate wasted water, and allows you to make savings in complete safety.

It is practical, compact and aesthetically integrated into the kitchen. No special installation is required, only the conventional installation process. All the technology is enclosed in a cartridge which can be replaced quickly and simply without recourse to equipment or the help of a specialist engineer. Each cartridge delivers 7000 litres of very pure water.

The flows are separate so that filtered water and purified water are kept apart throughout their trajectories.

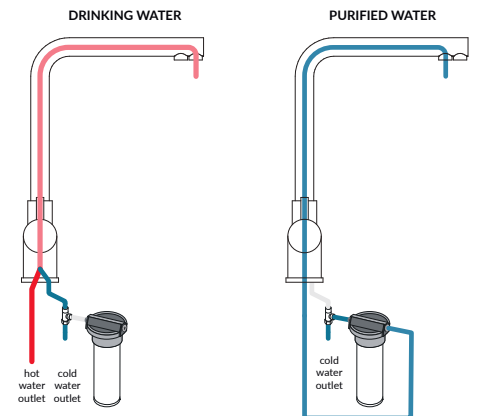

3-Way Glass mixer tap



LARGE SPRAY HEADS

Flexi mixer tap



Spring One mixer tap

with double delivery spray head



City mixer tap



Spring One mixer tap



Flexi mixer tap



City mixer tap



- ceramic disc cartridge
- tap rotation: 360°
- tap base: ø 50 mm
- tap hole: ø 35 mm

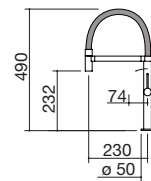

SATIN STAINLESS STEEL FINISH

code 1RUBMFX

NEW

- double delivery spray head
- ceramic disc cartridge
- tap rotation: 360°
- tap base: ø 50 mm
- tap hole: ø 35 mm

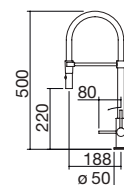

CHROME STAINLESS STEEL FINISH

code 1RUBSP1

- ceramic disc cartridge
- tap rotation: 360°
- tap base: ø 55 mm
- tap hole: ø 35 mm

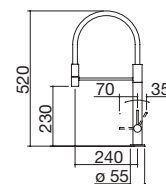

BLACK

code 1RUBCY

DISPENSERS

Smart Steel dispenser



NEW

- AISI 304 stainless steel
- dispenser with liquid soap/detergent holder, filled from the top, with a capacity of 250 ml
- container dimensions: \varnothing 56x150 h mm
- dispenser base: \varnothing 40 mm
- dispenser hole: \varnothing 35 mm
- it can be installed on a worktop thinner than or equal to 65 mm

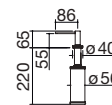

SATIN STAINLESS STEEL

code 1DSS

Smart Black dispenser



NEW

- dispenser with liquid soap/detergent holder, filled from the top, with a capacity of 250 ml
- container dimensions: \varnothing 56x150 h mm
- dispenser base: \varnothing 40 mm
- dispenser hole: \varnothing 35 mm
- it can be installed on a worktop thinner than or equal to 65 mm

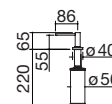

BLACK

code 1DSK

Smart Black dispenser



Smart Steel dispenser





PULL-OUT SPRAY HEAD

Pull-out spray head



- pull-out spray head
- compatible with: standard mixer tap, remote control mixer tap, independently powered
- spray head base: \varnothing 55 mm
- spray head hole: \varnothing 35 mm

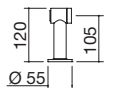

SATIN STAINLESS STEEL FINISH

code 1DCE

WORKTOP POWER SOCKET HOLDERS

Smart power socket holder with Schuko socket built-in



Smart power socket holder with USB ports built-in



- 1 Schuko socket
- dimensions: \varnothing 59 mm
- \varnothing 54 mm cut out

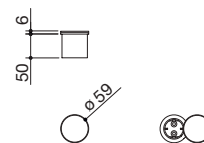

SATIN AISI 304 STAINLESS STEEL COVER

code 1PSS

- 2 USB ports (1 type A, 1 type C)
- dimensions: \varnothing 59 mm
- \varnothing 54 mm cut out

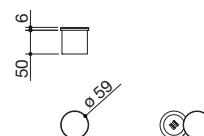

SATIN AISI 304 STAINLESS STEEL COVER

code 1PSU



POWER SOCKET TOWERS

Black Power pull-out socket tower
built-in



NEW

- 2 Schuko sockets
+ 2 USB ports (1 type A, 1 type C)
+ induction charger
- dimensions: \varnothing 90 mm
- \varnothing 82 mm cut out

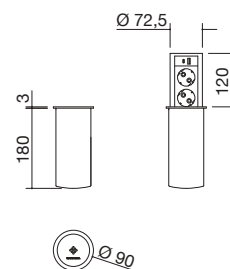

BLACK COVER

code 1TPKP



POWER SOCKET TOWERS

Steel pull-out power socket tower built-in



Black Matt pull-out socket tower built-in



NEW

- 2 Schuko sockets
- 2 USB ports (1 type A, 1 type C)
- dimensions: \varnothing 90 mm
- \varnothing 82 mm cut out

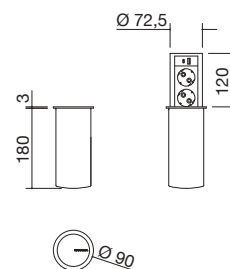

SATIN AISI 304 STAINLESS STEEL COVER code 1TPS

NEW

- 2 Schuko sockets
- 2 USB ports (1 type A, 1 type C)
- dimensions: \varnothing 90 mm
- \varnothing 82 mm cut out

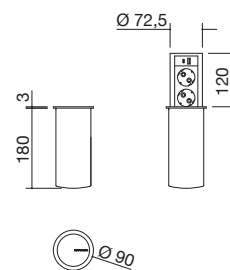

MATT BLACK COVER

code 1TPKM



WORKTOP POWER SOCKET HOLDERS

Up top power socket holder

built-in and flush



- 2 Schuko sockets + 1 USB port
- dimensions: 210x167 mm
- 195x157 mm cut out
flush-top: see website

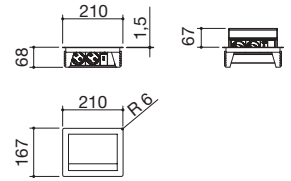

Rotating top power socket holder

built-in



- 2 Schuko sockets + 1 USB port
- cover with 180° rotating system
- dimensions: 225x105 mm.
215x88 mm cut out

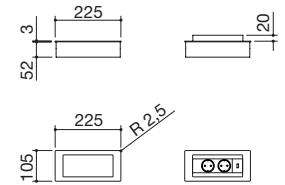

SATIN AISI 304 STAINLESS STEEL COVER code **1PPTU**

Rotating top power socket holder

built-in



- 2 Schuko sockets + 1 USB port
- cover with 180° rotating system
- dimensions: 225x105 mm.
215x88 mm cut out

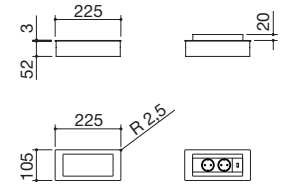

SATIN AISI 304 STAINLESS STEEL COVER code **1PPB**

Rotating top power socket holder

built-in



- 2 Schuko sockets + 1 USB port
- cover with 180° rotating system
- dimensions: 225x105 mm.
215x88 mm cut out

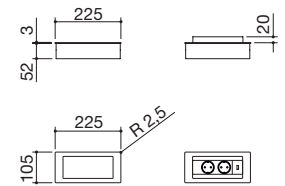

VINTAGE AISI 304 STAINLESS STEEL COVER code **1PPBV**

BLACK COVER

code **1PPBN**

SCALES

AISI 304 stainless steel scales built-in and flush



- extra-thick AISI 304 stainless steel
- weight range: 0-20 kg
- unit: g, kg, lb, oz
- accuracy: ± 1 g
- functions: tare, total, minute minder, multi-timer
- remote control for Barazza cooker hoods
- kitchen light switch 5 A 250 V
- automatic switch-off
- 100-240 V power supply
- maximum absorption 0.2 A
- 400x140 mm cut out
flush-top: see website

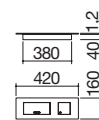

SATIN AISI 304 STAINLESS STEEL

code 1BL



INDUCTION CHARGER AND BLUETOOTH SPEAKER

New technological elements such as the powerful, intuitive Bluetooth speaker and the fast, efficient induction charger are ready to transform kitchen worktops and accessorised channels into multifunctional, interactive centres.

The kitchen becomes the heart of new energy that starts here and flows into all areas of life.



Induction charger built-in



- functions: supports fast charging, high efficiency charging (79%), LED warning light, selective device detection, safety switch-off
- input: 110-240 V AC, 50/60 Hz
- output: 5 V / 9 V - 1.1 A
- max. power: 10 W
- dimensions: \varnothing 68 mm
- \varnothing 60 mm cut out

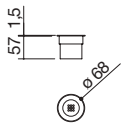

SATIN STAINLESS STEEL FINISH

code **1CBI**

Bluetooth speakers built-in



- functions: Bluetooth 5.0, 5-band digital hardware equaliser
- Bluetooth field: 10 m
- input: 110-240 V AC, 50/60 Hz
- max. power: 3 W
- dimensions: \varnothing 68 mm
- \varnothing 60 mm cut out

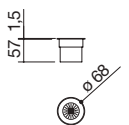

SATIN STAINLESS STEEL FINISH

code **1CAB**

ACCESSORIES SINKS AND SQUARE BOWLS

AISI 304 polished stainless steel basket



2 basket dimensions 32.5x32.5x14 h

code 1CQI

Polyethylene chopping board



8 chopping board dimensions 26x43

code 1TOF26

AISI 304 polished stainless steel hanging basket

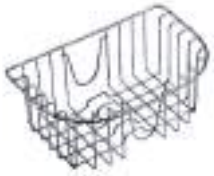

5 basket dimensions 36.5x23.5x15 h

code 1CREIM

Iroko chopping board



12 chopping board dimensions 40x35

code 1TRE

B_Free AISI 304 stainless steel and black HPL multi-purpose chopping board

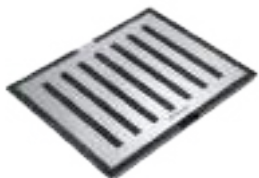

6 chopping board dimensions 33x41

code 1TBF

Polyethylene chopping board



13 chopping board dimensions 31.9x17.1

code 1TREPM

B_Free multi-purpose chopping board



Polyethylene chopping board



ACCESSORIES SINKS AND SQUARE BOWLS

Polyethylene chopping board



14 chopping board dimensions 40x35 code 1TREP

AISI 304 stainless steel perforated bowl cover



23 bowl cover dimensions 34x34 code 1CI33

24 bowl cover dimensions 40x35 code 1CI91

AISI 304 stainless steel colander



17 colander dimensions 15x43x12 H code 1VOF

18 colander dimensions 15x48x12 h code 1VLB

19 colander dimensions 12x41x6 h code 1VBF

AISI 304 stainless steel perforated bowl cover



25 bowl cover dimensions 25x43 code 1CIVQ

AISI 304 stainless steel colander with removable draining rack



20 colander dimensions 25x43x7 h code 1VSOF

21 colander dimensions 25x48x7 h code 1VSLB

AISI 304 stainless steel drain cover with basket



38 code 1CPI

Stainless steel roll-up multi-purpose rack



Stainless steel colander with removable draining rack



ACCESSORIES

SINKS AND SQUARE BOWLS

AISI 304 stainless steel perforated bowl cover with black HPL chopping board



40 bowl cover dimensions 25x43

code 1CITN

AISI 304 stainless steel roll-up multi-purpose rack

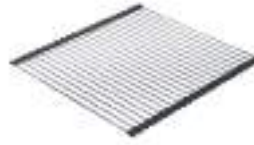

45 rack dimensions 46x44

code 1GSPA

Black HPL chopping board



43 chopping board dimensions 26x43

code 1TOF26N

Black HPL multipurpose drainer chopping board



46 chopping board dimensions 40x24

code 1TGMD

Black HPL sliding chopping board



44 chopping board dimensions 48x40

code 1TGSL

Black HPL sliding chopping board



47 chopping board dimensions 52x30

code 1TGS

Stainless steel perforated bowl cover with black HPL chopping board



Black HPL chopping board



ACCESSORIES SINKS AND SQUARE BOWLS

AISI 304 stainless steel perforated bowl cover with removable black HPL draining rack



61 bowl cover dimensions 25x43

code 1CIFX

Black HPL support grid for bowl bottom

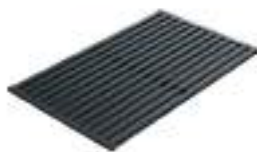

71 grid dimensions 33.8x38.3

code 1GQRN

AISI 304 stainless steel colander with removable black HPL draining rack



62 colander dimensions 25x43x7 h

code 1VSFX

63 colander dimensions 25x48x7 h

code 1VSQV

Solid oak wood Thalass chopping board



73 chopping board dimensions 25x35.9

code 1TTH

Black HPL support grid

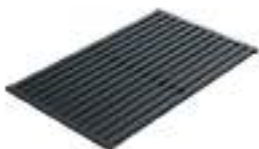

66 grid dimensions 26.5x43

code 1GLN

67 grid dimensions 26.5x48

code 1GQN

Black HPL support grid



Stainless steel colander with removable black HPL draining rack



POP-UP PLUG KIT

Pop-up plug kit



- control hole: \varnothing 35 mm
- stainless steel drain cover, $3\frac{1}{2}$ " basket strainer waste and perimeter overflow

64

code 1SPR

Black Smart pop-up plug kit



- control hole: \varnothing 35 mm
- with $3\frac{1}{2}$ " basket strainer waste and perimeter overflow

65

code 1SPSN

Smart pop-up plug kit



- control hole: \varnothing 35 mm
- with stainless steel drain cover, $3\frac{1}{2}$ " basket strainer waste and perimeter overflow

64

code 1SPSI

Black Smart pop-up plug kit



ACCESSORIES OVENS AND COORDINATED PRODUCTS

AISI 304 stainless steel pizza plate

NEW



28 dimensions of plate: 44.4x33.5 cm

code 1PPI

AISI 304 stainless steel pizza peel

NEW



79 peel dimensions : 44.7x30

code 1PPZ

2 pairs of telescopic oven rails kit



29 for 60 cm ovens (excluding Officina Advance)

code 1CG6

33 for 90 cm City ovens

code 1CG9

AISI 304 stainless steel air fryer basket



80 basket dimensions : 35.5x19x9.5 h

code 1CFFA

Pizza plate and peel



2 pairs of telescopic oven rails kit



Containers for vacuum-sealing kit



- container capacity
0.7 l Ø 14x7 h
1.4 l Ø 14x12.5 h
2 l Ø 14x18.5 h

57 container trays in 3 different sizes

code 1KS3

COOKER HOOD ACCESSORIES

Double carbon filter



41 for Mood, Unique, Lab Evolution, Steel cooker hoods

code 1FC1

72 for B_Ambient cooker hoods

code 1FCA1

Cloths for greasy filters

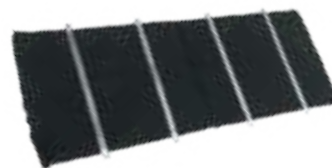

48 for 90 cm B_Draft cooker hood (x2)

code 1FC3

49 for 120 cm B_Draft cooker hood (x2)

code 1FC4

Containers for vacuum-sealing kit



ACCESSORIES HOB WITH INTEGRATED COOKER HOOD

Carbon filter kit for Zero Advance hob

NEW



code 1FZA

ACCESSORIES HOBS

Cast iron grill for induction hobs



74 grill dimensions 26x42

code 1BID

Ceramic filter kit for Zero Advance hob

NEW



code 1FCZA

Cast iron wok adapter



35 for double and triple rings
(excluding Lab Evolution and Mood hobs)

code 1RWJ

Rectangular ducting kit for Zero Advance hob

NEW



code 1TPZA

AISI 316 stainless steel splashback



81 for 80 cm Thalys teppanyaki

code 1PST

Plinth grille for Zero Advance hob outlet

NEW



code 1UZA

Sealant cartridge



for hobs and sinks installed flush with the top code 1CSF

Cast iron grill for induction hob



Cast iron wok adapter



CLEANING PRODUCTS

Easy Clean professional cleaning cream



- professional stainless steel cleaning cream
- clean, polish and protect stainless steel
- eco formula
- 150 g each

pack of 3 code **1ECO3**

pack of 12 code **1ECO12**

Multi Clean multipurpose professional detergent



- professional multipurpose cleaner, suitable for daily cleaning
- removes dirt quickly on all washable hard surfaces
- eco formula
- 200 ml each

pack of 3 code **1MC3**

pack of 12 code **1MC12**

Easy Clean professional microfibre cloth



- antibacterial
- clean and sanitise any surface in one go without the use of detergents
- dimensions: 40x40 cm

1 piece code **1PMA**

pack of 3 code **1PMA3**

Cleaning box



The Professional Cleaning Box contains:

- 1x Easy Clean 150 g
- 1x Multi Clean 200 ml
- 1x Easy Clean microfibre cloth

1 piece code **1CBK**

ICON KEY

CROSS ICONS

AISI 304 STAINLESS STEEL	SEALING	DOUBLE RING BURNER 4.7 KW	FILTER MAINTENANCE WARNING	SILENT WASH
4 MM THICK AISI 304 STAINLESS STEEL	VEGGY MODE	DOUBLE RING BURNER 5 KW	AIR CIRCULATION FUNCTION	SLIDING DOOR
AISI 316 STAINLESS STEEL	COOL DOOR	INDUCTION	REMOTE CONTROL INCLUDED	ADJUST BASKET HEIGHT
EXTRA-THICK STAINLESS STEEL	SOFT-CLOSE HINGES	ZONES IN LINE	ADJUSTABLE FLUE HEIGHT	SLIDING UPPER CUTLERY TRAY
ENERGY RATING A	ROTISSERIE	POWER MANAGEMENT	SMART WASH	ECO WASH
MODULE WIDTH	2 PAIRS OF TELESCOPIC OVEN RAILS	CHEF COOK FUNCTION	ADVANCED NO FROST	AQUAZONE
UNIT HEIGHT	TEMPERATURE PROBE	AUTOMATIC PAN DETECTION	TROPICAL 43°C	TURBO DRYING
LED LIGHTING	TURNABLE PLATE	SELECTIVE PAN DETECTION	METAL COOLING	TRIPLE WASH & DIRECT WASH
AUTOMATIC COOKING PROGRAMS		BRIDGE FUNCTION	TOUCH SCREEN DISPLAY WITH DUAL CONTROL	
SAFETY FUNCTION LOCK		BOOSTER	V-LIFT	
TOUCH CONTROL		PAUSE/REMINDER FUNCTION	LED LIGHTS	
TOUCH SCREEN		PREHEATING	VITAMOD	
SOFT-TOUCH FINISH		KEEP WARM	HUMIDITY CONTROL TECHNOLOGY	

HOBS

STAINLESS STEEL KNOBS
FLAT KNOBS
CAST IRON PAN SUPP.
BURNERS IN LINE
INTEGRATED BURNERS
ERGONOMIC GRIP
TEPPANYAKI
BARBECUE
TIMER
SAFETY SWITCH-OFF
FLAT ECO-DESIGN BURNERS
IGNITION WITH BATTERY
CHEF DOUBLE RING BURNER 3.5 KW
DOUBLE RING BURNER 3.5 KW
TRIPLE RING BURNER 3.8 KW
DOUBLE RING BURNER 4 KW

OVENS AND COORDINATED PRODUCTS

ZEFIRO SYSTEM
OVEN CAPACITY
EASY CLEAN OVEN INTERIOR
CONVECTION FUNCTIONS
MICROWAVE FUNCTIONS
STEAM FUNCTIONS
COFFEE MACHINE
WARMING DRAWER
VACUUM SEALER DRAWER
VACUUM SEALED IN BAG
VACUUM SEALED IN CONTAINER

COOKER HOODS

HOOD MOTOR EXTRACTION POWER
3 SPEEDS + INTENSIVE SPEED
PERIMETER EXTRACTION
SPECIAL COOKER HOOD FOR INDUCTION
HOOD-SCALES CONNECTION
STAINLESS STEEL FILTERS

REFRIGERATORS

METAL COOLING	TOUCH SCREEN DISPLAY WITH DUAL CONTROL
V-LIFT	LED LIGHTS
VITAMOD	HUMIDITY CONTROL TECHNOLOGY
ZERO DEGREE	SUPER COOL FUNCTION
FRUIT & VEG	FAST FREEZE
FAST FREEZE	DRINK COOL

SINKS AND BOWLS

BOWL RADIUS
LARGE BOWLS
STAINLESS STEEL COVER
PERIMETER OVERFLOW
STAINLESS STEEL DRAIN COVER
POP-UP PLUG
SMART POP-UP PLUG

TAPS AND ACCESSORIES

180° TAP ROTATION
MIXER TAP WITH REMOTE CONTROL
TELESCOPIC TAP
PULL-OUT SPRAY HEAD
PULL-OUT SPRAY HEAD

INSTALLATION

















UNDERMOUNTED
FLUSH
FLAT EDGE BUILT-IN

SOUL HIGH EDGE BUILT-IN
LOWERED EDGE BUILT-IN
STANDARD EDGE BUILT-IN





SQUARE EDGE BUILT-IN
FLAT GLASS EDGE BUILT-IN
4 MM EDGE BUILT-IN

MIZU KASAI BUILT-IN
THALAS EDGE BUILT-IN
FREESTANDING THALAS











60 CM OVENS functions key and general features

	Top + bottom heating element		Bottom heating element
	Top heating element		Traditional grill
	Maxi Grill		Grill + fan
	Top and bottom heating elements + fan		Circular and bottom heating elements + fan
	Circular heating element + fan		Defrosting
	Keep warm		Air frying
	Eco		Rapid defrost function
	Automatic cooking programs		Customisable cooking programs

75 CM OVENS functions key and general features

















	Top + bottom heating element		Bottom heating element
	Top and bottom heating elements + fan		Traditional grill (+ rotisserie)
	Maxi Grill (+ rotisserie)		Grill + fan (+ rotisserie)
	Circular and bottom heating elements + fan		Circular heating element + fan
	Eco		

90 CM OVENS functions key and general features

	Top + bottom heating element		Top and bottom heating elements + fan
	Bottom heating element		Traditional grill (+ rotisserie)
	Maxi Grill (+ rotisserie)		Grill + fan (+ rotisserie)
	Circular and bottom heating elements + fan		Circular heating element + fan
	Eco		Rapid defrost function



















COMPACT COMBI-MICROWAVE OVENS

functions key and general features

	Top + bottom heating element		Bottom heating element
	Traditional grill		Grill + bottom heating element
	Maxi Grill		Top and bottom heating elements + fan
	Grill + fan		Circular and bottom heating elements + fan
	Circular heating element + fan		Defrost (by weight / time)
	Combi-microwave + top and bottom heating elements		Microwave
	Combi-microwave + grill		Combi-microwave + circular heating element + fan
	Combi-microwave + grill + fan		Eco cooking
	Slow cooking		

COMPACT COMBI-STEAM OVEN

functions key and general features

	Top + bottom heating element		Bottom heating element
	Traditional grill		Grill + bottom heating element
	Maxi Grill		Top and bottom heating elements + fan
	Grill + fan		Circular and bottom heating elements + fan
	Circular heating element + fan		Defrosting
	Steam		Steam + hot air
	Sous vide steam		Combi-steam + top and bottom heating elements
	Combi-steam + grill		Combi-steam + grill + fan
	Combi-steam + circular heating element + fan		Eco cooking
	Slow cooking		

COMPACT COFFEE MACHINES

functions key and general features



Adjusting coffee strength



Pre-ground coffee



Select type of cup



Select double cups



Hot water delivery



Steam delivery



Automatic programming

VACUUM SEALER DRAWERS

functions key and general features



Vacuum sealed in bag



Chef function



Vacuum sealed in container



Sealing bags

MICROWAVE OVENS

Function key



Quick start



Microwave



Traditional grill



Grill + microwave



Timed defrost



Defrost by weight



ATTENTION IN MAKING, CARE IN FOLLOWING UP

Sales points

To get the up-to-date list of authorised distributors, go to the website www.barazzasrl.it.

Information service

Barazza provides an Information service to quickly respond to any requirements relating to:

- information about products and accessories
- problem solving
- instruction booklets
- information about methods of installation

To contact the Information Service directly:

email: customer@barazzasrl.it

Our attention to our customers is designed to guarantee that every Barazza product bears testimony to its handcrafted perfection and functionality over time. From design to creation to customer satisfaction: every Barazza creation is sculpted with care and excellence at the company's production site, and is followed up with an attentive after-sales service.

Reserved area

By entering your access details you can enter Barazza's restricted area where you can consult all the on-line documentation, the Mood, Lab and B_Free Fusion configurators and the interactive Made to Measure price list.

Shop on-line

Go to the Barazza on-line shop www.barazza.shop where you can purchase special cleaning products and a huge range of accessories for sinks, bowls, hobs, ovens and hoods along with a full range of power socket holders and accessories for accessorised channels.

General notes

Barazza reserves the right to make any changes it deems necessary to improve its products at any time and without prior warning. The colours shown are by way of example only. Full or partial reproduction of this catalogue for commercial purposes, without specific authorisation from Barazza, is strictly forbidden. The prices shown in the price list are net of VAT, transportation costs and any WEEE ECO contributions.

BARAZZA
taste of design

Barazza srl

31025 Sarano di S. Lucia di Piave (TV) ITALIA
Via Risorgimento, 14
Tel. +39 0438 62888 - Fax +39 0438 64901
info@barazzasrl.it - www.barazzasrl.it

